

H0002



H0003



H0101

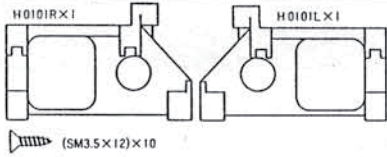

(SM3.5x12)x10

H0102

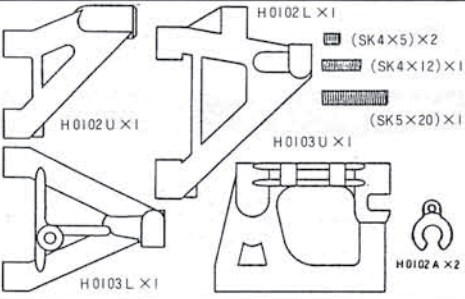

D0113



H0104

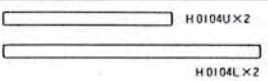

H0105

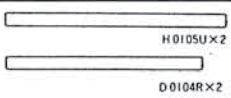

D0105

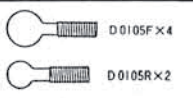

H0106

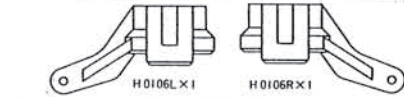

H0107

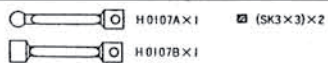

H0108



D0108



H0109



- H0002 INSTRUCTION MANUAL
- H0003 STING STICKER
- H0101 FRONT BULK HEAD
- H0102 SUS ARM SET
- D0113 SUS BRACKET
- H0104 FRONT SUS SHAFT
- H0105 REAR SUS SHAFT
- D0105 KING PIN
- H0106 FRONT UPRIGHT
- H0107 FRONT STABILIZER BAR
- H0108 FRONT STABI. HOLDER
- D0108 ADJUSTING NUT
- H0109 TOE IN ADJ. ROD

H0111

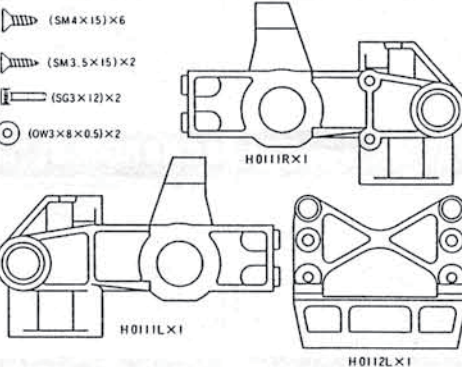

H0114



H0115

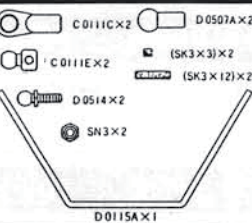

D0116

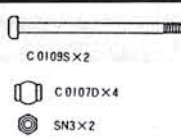

H0120

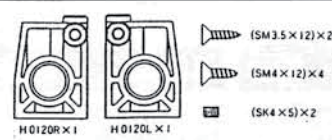

D0121

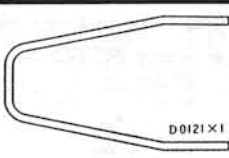

H0122 OPT

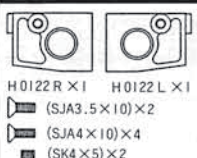

H0201

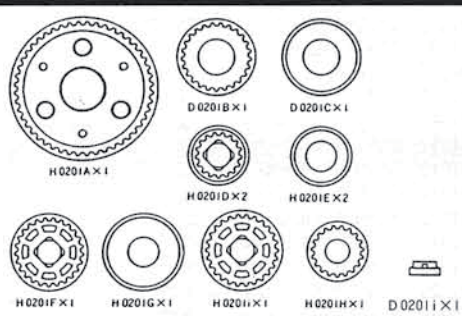

- H0111 REAR BULK HEAD
- H0114 REAR UPRIGHT
- H0115 REAR STABILIZER
- D0116 REAR UPPER SUS SHAFT
- H0120 MIDDLE BLOCK
- D0121 ROLL BAR
- H0122 ALUMI MIDDLE BLOCK
- H0201 PULLEY SET

H0204

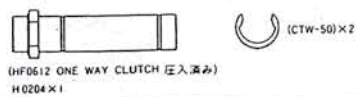

H0205



D0206



H0207

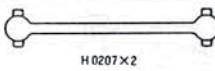

H0208

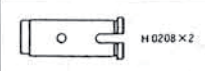

H0209

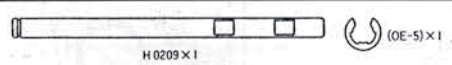

H0210

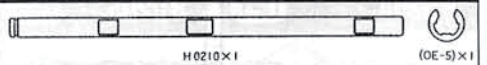

D0211

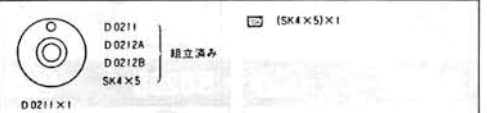

H0212



H0213

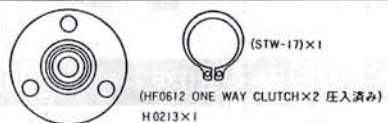

D0214

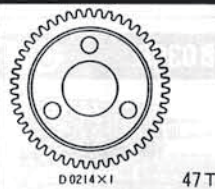

H0215

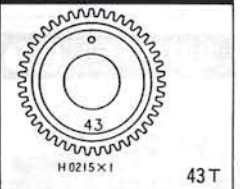

H0216



- H0204 FRONT ONE-WAY DRIVE SHAFT
- H0205 PULLEY HUB
- D0206 INNER DRIVE JOINT
- H0207 FRONT HALF SHAFT
- H0208 FRONT AXLE SHAFT
- H0209 MIDDLE SHAFT
- H0210 2 SPEED SHAFT
- D0211 GEAR CHANGING DRIVE DISK
- H0212 FRONT WHEEL CHANGING LEVER
- H0213 1ST GEAR HOUSING
- D0214 1ST GEAR 47T
- H0215 2ND GEAR 43T
- H0216 PULLEY/BRAKE ADAPTOR

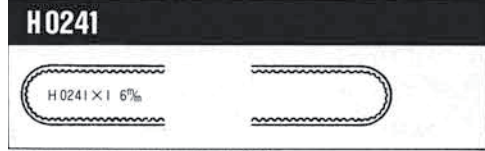
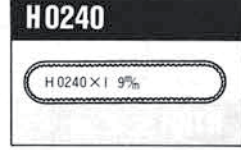
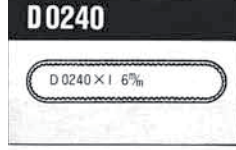
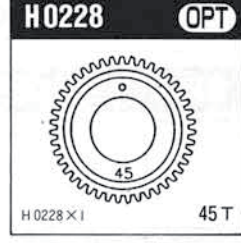
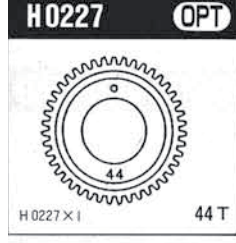
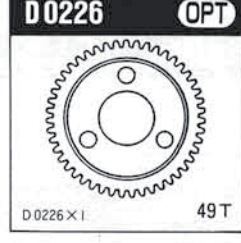
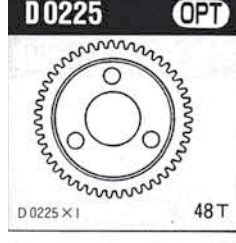
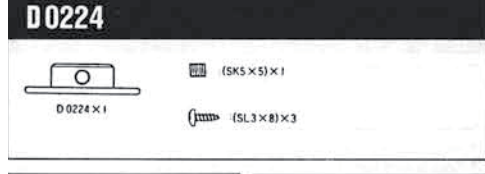
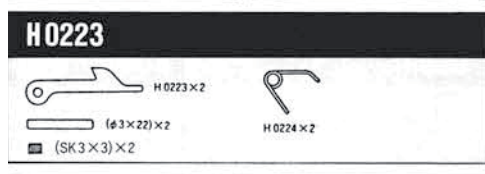
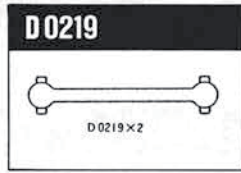
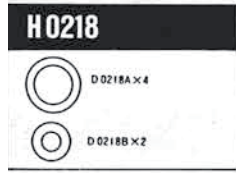
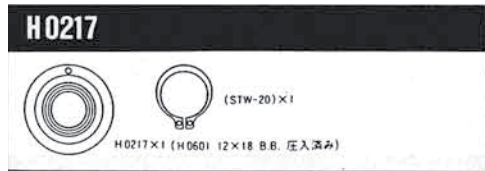

- H0217 2ND GEAR HOUSING
- H0218 AXLE WASHER
- D0219 REAR HALF SHAFT
- D0221 SOLID REAR AXLE
- H0222 REAR AXLE SHAFT
- H0223 REAR WHEEL CHANGING LEVER
- D0224 PULLEY ADAPTOR
- D0225 2 SPEED GEAR 48T
- D0226 2 SPEED GEAR 49T
- H0227 2ND GEAR 44T
- H0228 2ND GEAR 45T
- D0240 BELT S 6m/m
- H0240 BELT S 9m/m
- H0241 BELT L 6m/m

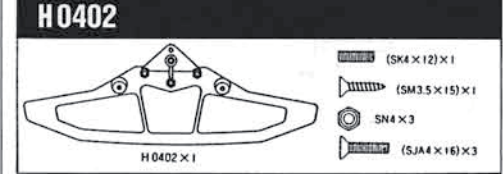
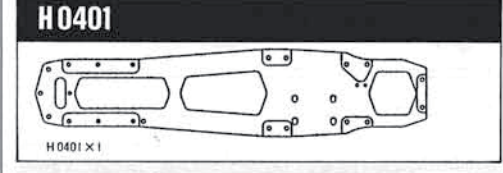
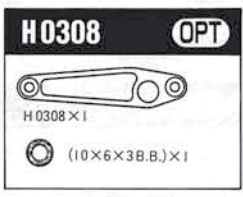
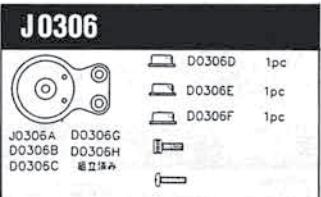
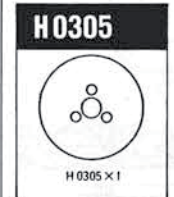
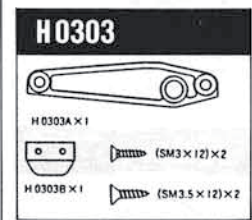
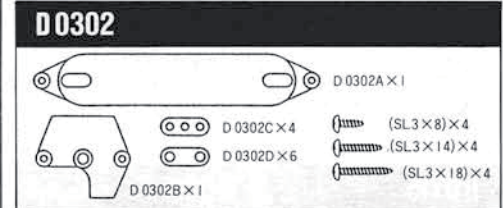
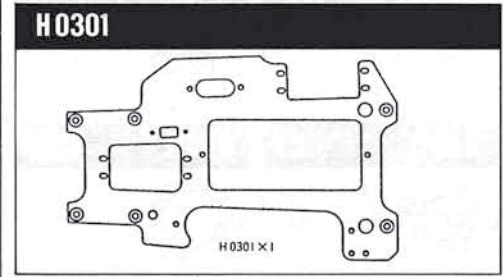
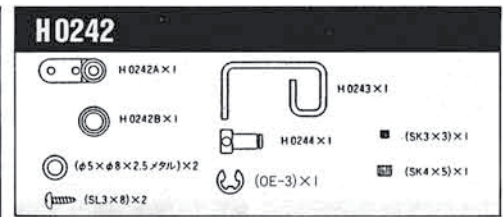



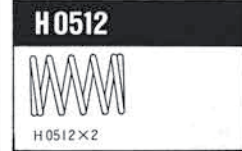
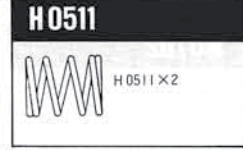
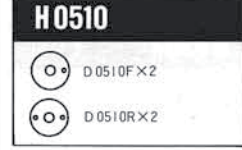
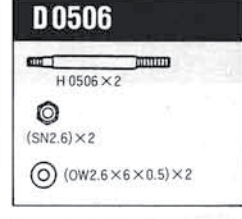
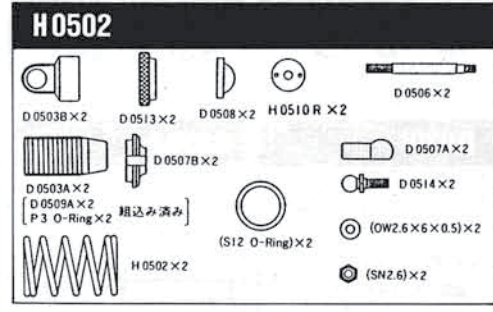
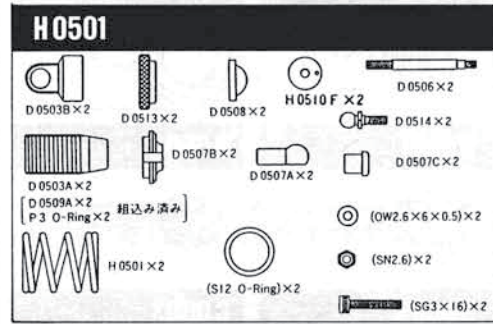
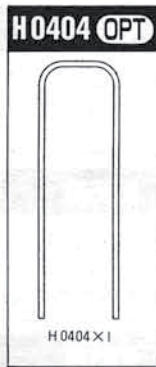
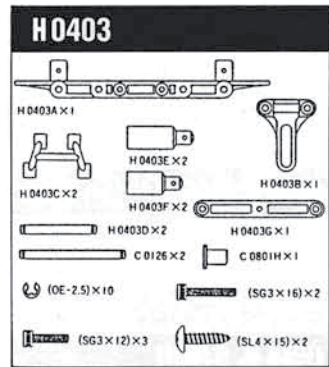

















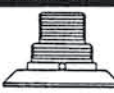





















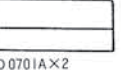



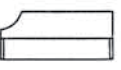
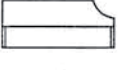
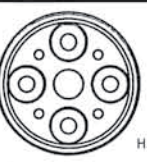
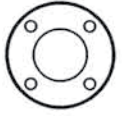









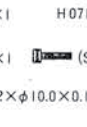
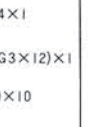





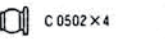
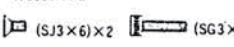

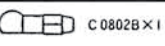

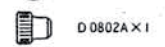

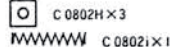
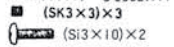
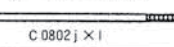
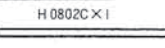
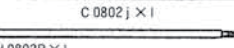
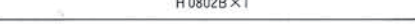
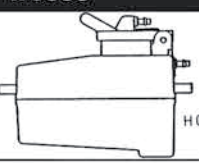
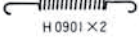

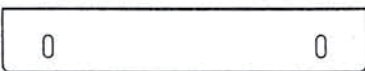

- H0242 BELT TENSIONER
- H0301 MECHA PLATE
- D0302 RADIO PARTS
- H0303 BRAKE CAM SUPPORT PLATE
- H0304 BRAKE CAM & BRAKE PAD
- H0305 BRAKE DISK
- J0306 SERVO SAVER
- H0307 TEFLON BRAKE PAD
- H0308 ALUMI. BRACKET
- H0401 CHASSIS
- H0402 BUMPER

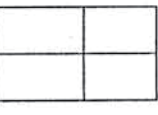

- H0403 REAR BODY MOUNT
- H0404 BODY STIFFENER WIRE
- H0501 FRONT DAMPER
- H0502 REAR DAMPER
- D0506 REAR DAMPER SHAFT
- D0507 DAMPER PLASTIC PARTS
- D0508 DIAPHRAGM
- D0509 O-RING SET
- H0510 DAMPER PISTON
- H0511 FRONT SPRING
- H0512 REAR SPRING
- H0513 SPRING ADJUSTER

1/8 SCALE 4WD GAS POWER RACING CAR STING PARTS LIST Ⅱ

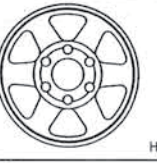
D0514  D0514×4	H0515 OPT  H0515×2	H0705  H0705×1	H0707  H0707×1	H0804  H0804A×2  (P3 O-Ring)×2  (SG3×8)×2  (SNAP Pin)×4  (P5 O-Ring)×2
H0516 OPT  H0516×2	H0517 OPT  H0517×2	H0708  H0708×1	H0710  H0710×1	D0806  D0806×2
H0518 OPT  H0518×2	D0601  D0601×2 (12×21)×2	H0711  H0711×1 18T	H0712 OPT  H0712×1 21T	D0807  D0807×8
H0601  H0601×2 (12×18)×2	D0602  D0602×2 (6×13)×2	H0713 OPT  H0713×1 17T	H0714  H0714×1 20T	D0808 OPT  (OE3)×8  (OE5)×10  (OE7)×2
D0603  (5% スラストベアリング) (5% THRUST B.B.)	C0603  C0603×2 (5×10)×2	H0715  H0715×1	H0716  H0716×1  (SG3×12)×1  (OW φ5.2×φ10.0×0.1)×10	D0809 OPT  (CTW-46)×4  (CTW-50)×2  (CTW-17)×4
D0701  D0701A×2  (SG3×12)×4  (SJA4×10)×4  (OWS3)×4	D0702 OPT  D0722 L×1  D0722 R×1	H0720  H0720×1	H0721  H0721×1	D0811 OPT  (SJA3.5×12)×20
H0701/1  H0720×1  H0707×1  H0704×1  H0708×1  H0711×1  H0721×1  H0710×1  H0705×1  H0714×1  H0715×1  H0702×4  H0716×1  (SG3×12)×1  (OW φ5.2×φ10.0×0.1)×10	H0801  C0111C×4  H0801A×2  C0502×4  (Sj3×6)×2  (SG3×12)×2	H0802  C0802B×1  C0802G×2  D0802A×1  H0802A×1  C0802H×3  C0802i×1 (SK3×3)×3  (Si3×10)×2  H0802C×1  C0802j×1  H0802B×1	H0803  H0803×1	H0901 OPT  H0901×2
H0702  H0702×4	H0704  H0704×1	H1004 OPT  H1005×1  H1006A×2  H1006B×2	H1005 OPT  H1005×1	H1006 OPT  H1006A×2  H1006B×2
		H1007 OPT  H1007A×2  H1007C×2  H1007B×2  H1007D×1	H1101  H1101×2	H1102  H1102×2

D0514 DAMPER PIVOT BALL
 H0515 FRONT SPRING φ1.8(YELLOW)
 H0516 FRONT SPRING φ2.0(BLUE)
 H0517 REAR SPRING φ1.5(YELLOW)
 H0518 REAR SPRING φ1.7(BLUE)
 D0601 BEARINGS (12×21)
 H0601 BEARINGS (12×18)
 D0602 BEARINGS (6×13)
 D0603 THRUST BEARINGS 5m/m
 C0603 CLUTCH BEARINGS (5×10)
 D0701 ENGINE MOUNT
 D0702 ALUMI. ENGINE MOUNT
 H0701/1 AUTOMATIC CLUTCH SET
 H0702 CLUTCH BALLS
 H0704 ENGINE NUT
 H0705 ADJ. NUT

H0707 CLUTCH SHOE
 H0708 CLUTCH SPRING
 H0710 CLUTCH BELL
 H0711 1ST GEAR 18T
 H0712 2ND GEAR 21T
 H0713 1ST GEAR 17T
 H0714 2ND GEAR 20T
 H0715 SPRING CUP
 H0716 STOPPER COLLAR
 H0720 FLYWHEEL
 H0721 PRESSURE PLATE
 H0801 STEERING LINKAGE
 H0802 ENCON LINKAGE
 H0803 FUEL TANK

H0804 FUEL TANK HOLDER
 D0806 ANTENNA PIPE
 D0807 BODY PIN
 D0808 E-RING SET
 D0809 C-RING SET
 D0811 SJA 3.5m/m FLAT SCREW
 H0901 MANIFOLD SPRINGS
 C0901 MUFFLER STAY
 H1004 REAR SPOILER SET
 H1005 REAR SPOILER
 H1006 REAR SPOILER ADJ. SCREW
 H1007 BODY STIFFENER
 H1101 FRONT WHEEL (WHITE)
 H1102 REAR WHEEL (WHITE)

ツリスト

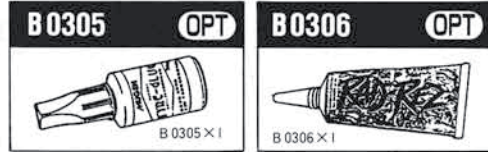
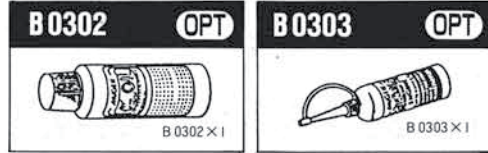
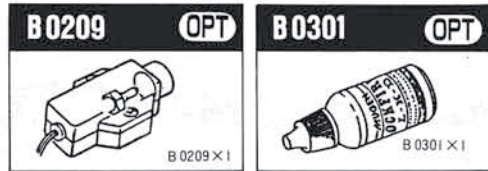
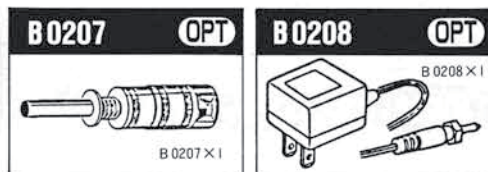
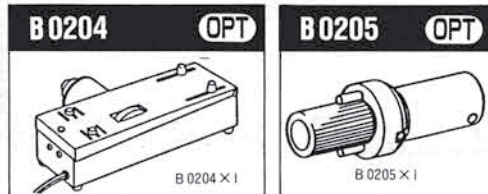
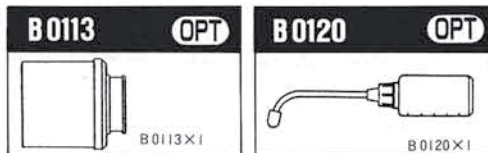

- B0103 FUEL FILTER L
- B0104 FUEL FILTER S
- B0107 QUICK FUEL PUMP (GREEN)
- B0108 QUICK FUEL PUMP (PINK)
- B0109 QUICK FUEL PUMP (YELLOW)
- B0113 AIR FILTER (21 ON ROAD)
- B0120 FUEL PUMP SMALL
- B0202 NEW STARTER RING
- B0203 QUICK BOOSTER
- B0204 PRO STARTER R
- B0205 HUB FOR TYER TRUER
- B0207 POCKET BOOSTER
- B0208 DC ADAPTOR FOR POCKET BOOSTER

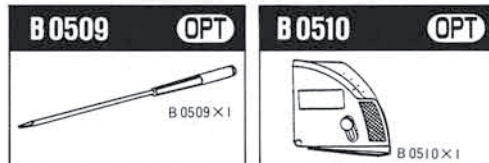
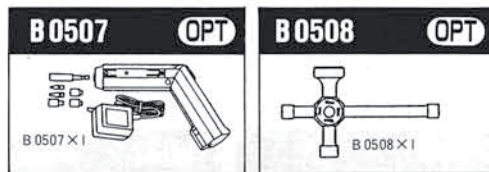
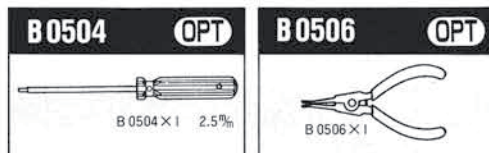
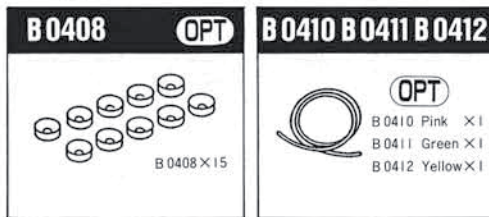
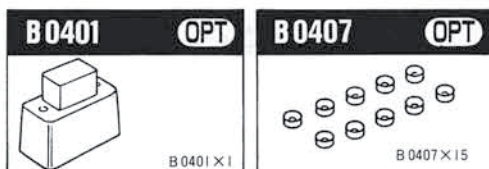

- B0301 LOCKFIRM LIQUID
- B0302 AIR FILTER OIL
- B0303 ENGINE MAINTENANCE OIL
- B0305 TYER GLUE
- B0306 RAD-REZ
- B0310 SUPER SILICONE #100
- B0311 SUPER SILICONE #150
- B0312 SUPER SILICONE #200
- B0313 SUPER SILICONE #250
- B0314 SUPER SILICONE #300
- B0315 SUPER SILICONE #350
- B0316 SUPER SILICONE #400
- B0325 SUPER SILICONE #500
- B0326 SUPER SILICONE #600
- B0327 SUPER SILICONE #700
- B0328 SUPER SILICONE #800
- B0401 SWITCH COVER
- B0407 FLAT WASHER 3m/m
- B0408 FLAT WASHER 4m/m
- B0410 COLOR SILICONE PIPE (PINK)
- B0411 COLOR SILICONE PIPE (GREEN)
- B0412 COLOR SILICONE PIPE (YELLOW)
- B0414 MUFFLER JOINT SILICONE PIPE L
- B0416 COLOR STRAP SET 100m/m
- B0417 COLOR STRAP SET 150m/m
- B0502 WORKS WRENCH 1.5m/m
- B0503 WORKS WRENCH 2.0m/m
- B0504 WORKS WRENCH 2.5m/m

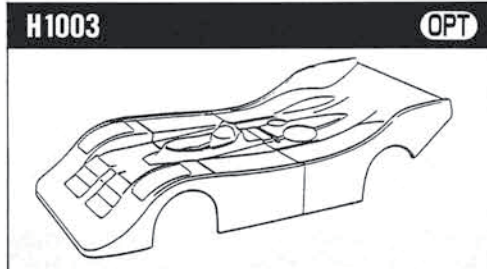
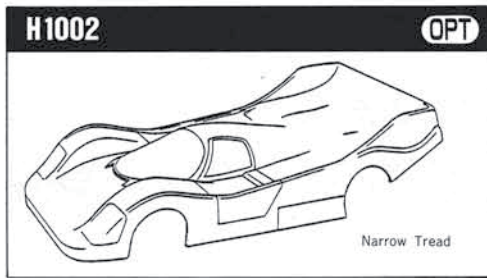
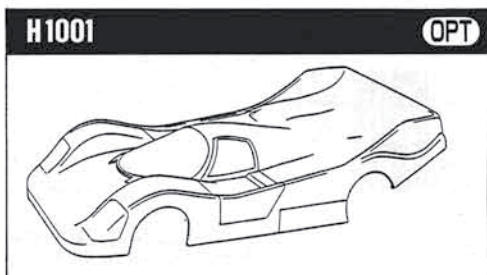

- B0506 SNAP RING PLIERS
- B0507 CORDLESS SCREW DRIVER
- B0508 UTILITY WRENCH
- B0509 SETTING DRIVER FOR ENGINE
- B0510 CAMBER GAUGE
- H1001 C-CAR TYPE BODY
- H1002 C-CAR TYPE BODY Narrow Tread
- H1003 LOLA VDS



MUGEN SEIKI CO., LTD.

株式会社 無限精機
〒274 千葉県船橋市高根町1395 PHONE:0474-30-1663
表示価格には消費税は含まれていません。 No.2