

1/8 Scale Electric 4WD Truggy MBX8TR ECO Parts List (E2030)

1/8 Scale MBX8TR ECO Parts List (E2030)

1/8 Scale MBX8TR ECO パーツリスト (E2030)

1/8スケール MBX8TR ECO パーツリスト (E2030)

E2160-B

NO.03

B,C,D-Parts

B0431a B0431 4pcs.

B0432 B0432 5pcs.

C0107Da C0107D 4pcs.

C0264 C0261 2pcs.
SK4x4 2pcs.

C0270 φ3x12.8 Pin 10 pcs.

C0271 φ3x13.8 Pin 10 pcs.

C0529Aa C0529A 4pcs.

C0601 C0601 2pcs. (8x16x5)

C0601/1a C0601 10pcs. (8x16x5)

C0605 C0605 2pcs. (6x10x3)

C0801Ha C0801H 2pcs.

D0602 D0602 2pcs. (6x13x5)

D0807 D0807 8pcs.

E0219a E0219 4pcs.

E0221 E0221 2pcs.

E0238 φ2.5x14.8 Pin 10pcs.

E0239a OPT E0239 2pcs.

E0240a OPT E0240 2pcs.

E0241a E0241 2pcs.

E0242 OPT E0242 2pcs.

E0322 E0322 1pc.

E0517 E0517 2pcs.

E0518 E0518 2pcs.

E0519 E0519 2pcs.

E0520 E0520 4pcs.
C0590A 4pcs.
P3.5 O-Ring(Si)8pcs.

E0575 E0576 E0577 E0578 E0582 OPT

E0575 φ 1.5 L86/8.5T 2pcs. OPT
E0576 φ 1.5 L86/8.25T 2pcs. OPT
E0577 φ 1.5 L86/8.0T 2pcs. OPT
E0578 φ 1.5 L86/7.75T 2pcs. OPT
E0582 φ 1.5 L86/8.75T 2pcs. OPT

E0601a E0601 2pcs. (15x21x4)

E0601/1b E0601 10pcs. (15x21x4)

E0711 OPT 12T 1pc.
SK4x4 1pc.

E0712 OPT 13T 1pc.
SK4x4 1pc.

E0713 OPT 14T 1pc.
SK4x4 1pc.

E0714 15T 1pc.
SK4x4 1pc.

E0715 OPT 16T 1pc.
SK4x4 1pc.

E0716 OPT 17T 1pc.
SK4x4 1pc.

E0803 E0803 2pcs.

E0806 E0806A 1pc.

E0808a OPT E0808 1pc.

E0813 E0813A 2pcs.
E0813B 2pcs.

E0814 E0814A 2pcs.
E0814B 2pcs.

E2115 E2115 2pcs.

E2116 E2116 2pcs.

E2120 E2120 2pcs.

E2121Ba OPT E2121B 2pcs.

E2123 OPT E2123 2pcs.

E2124 OPT E2124 2pcs.

E2136 E2137 E2184 OPT E2136 φ2.7 1pc.
E2137 φ2.8 1pc.
E2184 φ2.0 1pc.

E2138 E2185 OPT E2138 φ2.5 1pc.
E2185 φ2.4 1pc.

E2139a OPT E2139 4pcs.

E2141Aa E2141A 1pc.

E2141Ba E2141B 1pc.

E2142a E2142A 1pc.
E2142B 1pc.
E2142C 1pc.

E2160-B

E2160A 1pc.
E1088D 1pc.
E0188C 1pc.
E0188E 1pc.
E0188F 1pc.
E0188B-B 1pc.

E2161a

E2161L 1pc.
E2161A 1pc.
E2161R 1pc.
E2161B 1pc.

E2162a

E2162L 1pc.
E2162A 1pc.
E2162R 1pc.
E2162B 1pc.

E2163a

E2163B 1pc.
E0181A 1pc.
E2163C 2pcs.
E0181E 2pcs.
E2163D 1pc.

E2164a E2164L 1pc.
E2164R 1pc.

E2165 E2165 2pcs.

E2166a OPT E2166 2pcs. (1.2mm)

E2167a OPT E2167 2pcs. (1.2mm)

E2168a E2168R 1pc.
E2168L 1pc.

E2172 E2172L 1pc.
E2172R 1pc.

E2173

E2173A 6pcs.
E2173B 6pcs.
E2173C 6pcs.
E2108B 4pcs.
E2173D 2pcs.
E2173E 2pcs.
E2173F 2pcs.
E2108A 4pcs.
E2108F(1mm) 2pcs.
E2108G(1.5mm) 2pcs.
E2108H(2.5mm) 2pcs.

E2174 E2174 1pc.

E2177 E2177 4pcs.

E2178 OPT E2178 4pcs.

E2179 E2179 4pcs.

E2182 OPT E2182A 4pcs.
E2182B 4pcs.
E2182L 1pc.
E2182R 1pc.
SIG3x8 8pcs.

E2182A/B OPT E2182A 4pcs.
E2182B 4pcs.

E2182L OPT E2182L 1pc.

E2182R OPT E2182R 1pc.

E2186 E2186 1pc.

E2187 E2187 1pc.

E2188 OPT E2188L 1pc.
E2188R 1pc.

E2189 OPT E2189L 1pc.
E2189R 1pc.

E2230 OPT E2230 1pc.
SK5x5 1pc.

E2231 OPT E2231 1pc.
SK5x5 1pc.

E2232a E2232 1pc.

E2237 E2237 2pcs.

E2238a E2238 4pcs. 10T

E2240a E2240 2pcs.

E2241 E2241 10pcs.

E2242a S6 O-Ring(Si) 10pcs.

E2243 OW3.5x12x0.2 12pcs.
OW6x12x0.2 6pcs.

E-Parts

E0135-Ba

E0135A 12pcs. (1mm)
E0135B 2pcs. (1.2mm)

E0135C 2pcs. (1.4mm)
E0135D 2pcs. (2mm)

E0135E 2pcs. (0.9mm)
E0135F 2pcs. (1.1mm)

E0155 E0155 4pcs.

E0159 E0159 4pcs.

E0160a E0160 2pcs.

E0161a E0161 4pcs.

E0162a E0162 2pcs.

E0163 E0164 E0165 E0166 E0167 E0175 OPT

E0163 φ2.2 1pc. OPT
E0164 φ2.3 1pc. OPT
E0165 φ2.4 1pc. OPT

E0166 φ2.5 1pc. OPT
E0167 φ2.6 1pc. OPT
E0175 φ2.1 1pc. OPT

E0168 E0169 E0170 E0171 E0176 OPT

E0168 φ2.7 1pc.
E0169 φ2.8 1pc. OPT
E0170 φ2.9 1pc. OPT

E0171 φ3.0 1pc. OPT
E0176 φ2.6 1pc. OPT

E0174 OW5x8x0.1 10pcs.
OW13.5x15.9x0.2 5pcs.

E0183 E0183 5pcs.

E0210 φ3x16.8 Pin 8pcs.

E0545a E0545A 4pcs.
E0545B 4pcs.

E0546a E0546 4pcs.

E0548b E0548 4pcs.

E0551 E0552 E0553 E0558 E0559 E0560 OPT

E0551 φ 1.6 L75/9.5T 2pcs. OPT
E0552 φ 1.6 L75/9.25T 2pcs. OPT
E0553 φ 1.6 L75/9.0T 2pcs. OPT
E0558 φ 1.6 L75/10.25T 2pcs. OPT
E0559 φ 1.6 L75/10.0T 2pcs. OPT
E0560 φ 1.6 L75/9.75T 2pcs. OPT

E0554 E0555 E0556 E0561 E0562 E0563 OPT
E0568 E0569

E0554 φ 1.6 L86/10.5T 2pcs. OPT
E0555 φ 1.6 L86/10.25T 2pcs. OPT
E0556 φ 1.6 L86/10.0T 2pcs. OPT
E0561 φ 1.6 L86/11.25T 2pcs. OPT
E0562 φ 1.6 L86/11.0T 2pcs. OPT
E0563 φ 1.6 L86/10.75T 2pcs. OPT
E0568 φ 1.6 L86/9.75T 2pcs. OPT
E0569 φ 1.6 L86/9.5T 2pcs. OPT

E0571 E0572 E0573 E0574 E0581 OPT

E0571 φ 1.5 L75/8.25T 2pcs. OPT
E0572 φ 1.5 L75/8.0T 2pcs. OPT
E0573 φ 1.5 L75/7.75T 2pcs. OPT
E0574 φ 1.5 L75/7.5T 2pcs. OPT
E0581 φ 1.5 L75/8.5T 2pcs. OPT

E0829a E0829 4pcs.

E0834 E0834 2pcs.

E0835 OPT E0835 2pcs.

E1081W OPT E1081W 1pc. (White)

E1081Y OPT E1081Y 1pc. (Yellow)

E1081B OPT E1081B 1pc. (Black)

E1085

E2146a E2146R 1pc.
E2146L 1pc.
E0151A 4pcs.

E2147a OPT E2147R 1pc.
E2147L 1pc.
E0151A 4pcs.

E2148a E2107A 1pc.
E2107B 1pc.
E2148B 1pc.
E2148D 1pc.
E2148A 1pc.
E2107F 1pc.
E0188E 1pc.
E2148C 2pcs.

E2149a E2149 1pc.

E2150a E2150 1pc.

E2153a OPT E2153R 1pc.
E2153L 1pc.

E2158a OPT E2158 1pc.
SIG3x12 1pc.
SJG4x10 2pcs.
Manual 1pc.

E2160-B

E2161a

E2162a

E2163a

E2164a E2164L 1pc.
E2164R 1pc.

E2165 E2165 2pcs.

E2166a OPT E2166 2pcs. (1.2mm)

E2167a OPT E2167 2pcs. (1.2mm)

E2168a E2168R 1pc.
E2168L 1pc.

E2172 E2172L 1pc.
E2172R 1pc.

E2173

E2174 E2174 1pc.

E2177 E2177 4pcs.

E2178 OPT E2178 4pcs.

E2179 E2179 4pcs.

E2182 OPT E2182A 4pcs.
E2182B 4pcs.
E2182L 1pc.
E2182R 1pc.
SIG3x8 8pcs.

E2182A/B OPT E2182A 4pcs.
E2182B 4pcs.

E2182L OPT E2182L 1pc.

E2182R OPT E2182R 1pc.

E2186 E2186 1pc.

E2187 E2187 1pc.

E2188 OPT E2188L 1pc.
E2188R 1pc.

E2189 OPT E2189L 1pc.
E2189R 1pc.

E2230 OPT E2230 1pc.
SK5x5 1pc.

E2231 OPT E2231 1pc.
SK5x5 1pc.

E2232a E2232 1pc.

E2237 E2237 2pcs.

E2238a E2238 4pcs. 10T

E2240a E2240 2pcs.

E2241 E2241 10pcs.

E2242a S6 O-Ring(Si) 10pcs.

E2243 OW3.5x12x0.2 12pcs.
OW6x12x0.2 6pcs.

B,C,D-Parts

B0431a 3mm CONE WASHER

B0432 ANTENNA CAP (5pcs.)

C0107Da PIVOT BALL φ7mm

C0264 JOINT SHAFT

C0270 JOINT PIN(FOR E2228/E2229/E2261/E2262)

C0271 JOINT PIN(FOR E2218/E2219/E0222)

C0529Aa LINK BALL

C0601 BEARINGS (8x16x5) 2pcs.

C0601/1a BEARINGS (8x16x5) 10pcs.

C0605 BEARINGS (6x10x3) 2pcs.

C0801Ha PIVOT BUSH

D0602 BEARINGS (6x13x5) 2pcs.

D0807 BODY PIN 15/21

E-Parts

E0135-Ba SUS. ARM SPACER

E0155 ANTI ROLL BAR LINK

E0159 ADJUST NUT

E0160a FRONT LOWER KINGPIN BALL

E0161a FRONT TRACK WIDTH ADJUST SPACER

E0162a FRONT UPPER ARM SHAFT

E0163 FRONT ANTI ROLL BAR φ2.2mm

E0164 FRONT ANTI ROLL BAR φ2.3mm

E0165 FRONT ANTI ROLL BAR φ2.4mm

E0166 FRONT ANTI ROLL BAR φ2.5mm

E0167 FRONT ANTI ROLL BAR φ2.6mm

E0168 REAR ANTI ROLL BAR φ2.7mm

E0169 REAR ANTI ROLL BAR φ2.8mm

E0170 REAR ANTI ROLL BAR φ2.9mm

E0171 REAR ANTI ROLL BAR φ3.0mm

E0174 WASHER SET

E0175 FRONT ANTI ROLL BAR φ2.1mm

E0176 REAR ANTI ROLL BAR φ2.6mm

E0183 REBOUND STOP ADJ. SCREW

E0210 φ3x16.8 PIN (8pcs.)

E0219a SELF-LOCK WHEEL NUT

E0221 F/R AXLE SHAFT

E0238 JOINT PIN (φ2.5x14.8)(FOR E0220/E0221/E0242)

E0239a WHEEL HUB

E0240a WIDE OFFSET WHEEL HUB 1mm

E0241a WIDE OFFSET WHEEL HUB 2mm

E0242 AL. F/R AXLE SHAFT

E0322 RADIO BOX GROMMET

E0517 FRONT DAMPER SHAFT

E0518 REAR DAMPER SHAFT

E0519 OIL SEAL CAP

E0520 OIL SEAL SET

E0545a DAMPER END PARTS

E0546a DAMPER MOUNT PIVOT BUSH

E0548b DAMPER MOUNT PIVOT

E0551 FRONT DAMPER SPRING φ1.6 L75/9.5T

E0552 FRONT DAMPER SPRING φ1.6 L75/9.25T

E0553 FRONT DAMPER SPRING φ1.6 L75/9.0T

E0558 FRONT DAMPER SPRING φ1.6 L75/10.25T

E0559 FRONT DAMPER SPRING φ1.6 L75/10.0T

E0560 FRONT DAMPER SPRING φ1.6 L75/9.75T

E0554 REAR DAMPER SPRING φ1.6 L86/10.5T

E0555 REAR DAMPER SPRING φ1.6 L86/10.25T

E0556 REAR DAMPER SPRING φ1.6 L86/10.0T

E0561 REAR DAMPER SPRING φ1.6 L86/11.25T

E0562 REAR DAMPER SPRING φ1.6 L86/11.0T

E0563 REAR DAMPER SPRING φ1.6 L86/10.75T

E0568 REAR DAMPER SPRING φ1.6 L86/9.75T

E0569 REAR DAMPER SPRING φ1.6 L86/9.5T

E0571 FRONT DAMPER SPRING φ1.5 L75/8.25T

E0572 FRONT DAMPER SPRING φ1.5 L75/8.0T

E0573 FRONT DAMPER SPRING φ1.5 L75/7.75T

E0574 FRONT DAMPER SPRING φ1.5 L75/7.5T

E0581 FRONT DAMPER SPRING φ1.5/8.5T

E0575 REAR DAMPER SPRING φ1.5 L86/8.5T

E0576 REAR DAMPER SPRING φ1.5 L86/8.25T

E0577 REAR DAMPER SPRING φ1.5 L86/8.0T

E0578 REAR DAMPER SPRING φ1.5 L86/7.75T

E0582 REAR DAMPER SPRING φ1.5 L86/8.75T

E0601a BEARINGS (15x21x4) 2pcs.

E0601/1b BEARINGS (15x21x4) 10pcs.

E0711 PINION GEAR 12T

E0712 PINION GEAR 13T

E0713 PINION GEAR 14T

E0714 PINION GEAR 15T

E0715 PINION GEAR 16T

E0716 PINION GEAR 17T

E0717 FUEL TANK BUSH

E0803 TURNBUCKLE ROD 35mm

E0806 TITANIUM TURNBUCKLE ROD 35mm

E0813 REAR UPPER ARM LINK

E0814 BALL LINK φ7mm

E0829a ANTI-ROLL BAR LINK BALL

E0834 STEERING ROD 90

E0835 TITANIUM STEERING ROD 90

E1081W REAR WING (WHITE)

E1081Y REAR WING (YELLOW)

E1081B REAR WING (BLACK)

E1085 MBX8TR ECO INSTRUCTION MANUAL

E2115 FRONT LOWER ARM SHAFT

E2116 REAR LOWER ARM SHAFT S

E2120 REAR LOWER ARM SHAFT L

E2121Ba SERVO SAVER SPACER(FOR E2121/E2158)

E2123 KINGPIN BALL (STEEL)

E2124 ADJUST NUT (STEEL)

E2136 FRONT ANTI ROLL BAR φ2.7mm

E2137 FRONT ANTI ROLL BAR φ2.8mm

E2138 REAR ANTI ROLL BAR φ2.5mm

E2139a FRONT TRACK WIDTH ADJUST SPACER(0.5mm)

E2141Aa MOTOR MOUNT A

E2141Ba MOTOR MOUNT B

E2142a GEAR BOX

E2146a FRONT UPRIGHT

E2147a FRONT UPRIGHT(1.5)

E2148a TENSION ROD

E2149a FRONT LOWER ARM MOUNT F

E2150a FRONT LOWER ARM MOUNT R

E2153a FRONT UPRIGHT ARM CFRP

E2158a FRONT UPPER PLATE CFRP

E2160-B CENTER DIFF. MOUNT

E2161a FRONT LOWER ARM

E2162a REAR LOWER ARM

E2163a TENSION ROD

E2164a FRONT UPPER ARM

E2165 REAR UPPER ARM ROD 47

E2166a FRONT LOWER ARM PLATE (1.2mm)CFRP

E2167a REAR LOWER ARM PLATE (1.2mm)CFRP

E2168a FRONT UPRIGHT ARM (-3)

E2172 REAR HUBS

E2173 ARM MOUNT INSERT SET

E2174 FRONT LINK MOUNT

E2177 REAR LINK PLATES (+3)

E2178 REAR LINK PLATES (0)

E2179 ANTI-ROLL BAR STOPPER

E2182 AL. REAR HUB SET

E2182A/B AL. REAR HUB BUSH SET

E2182L AL. REAR HUB (L)

E2182R AL. REAR HUB (R)

E2184 FRONT ANTI-ROLL BAR (φ2.0mm)

E2185 REAR ANTI-ROLL BAR (φ2.4mm)

E2186 REAR LOWER ARM MOUNT F

E2187 REAR LOWER ARM MOUNT R

E2188 LW FRONT LOWER ARMS

E2189 LW REAR LOWER ARMS

E2230 CENTER UNIVERSAL JOINT F (82.5)

E2231 CENTER UNIVERSAL JOINT R (156.5)

E2232a DIFF. CASE (H.T. DIFF.)

E2237 DIFF. CUP JOINT (H.T. DIFF.)

E2238a DIFF. GEAR 10T (H.T. DIFF.)

E2240a DIFF. SHAFT (H.T. DIFF.)

E2241 GASKET FOR DIFF. (H.T. DIFF.)

E2242a S6 O-RINGS Si (H.T. DIFF.)

E2243 DIFF. WASHER SET (H.T. DIFF.)

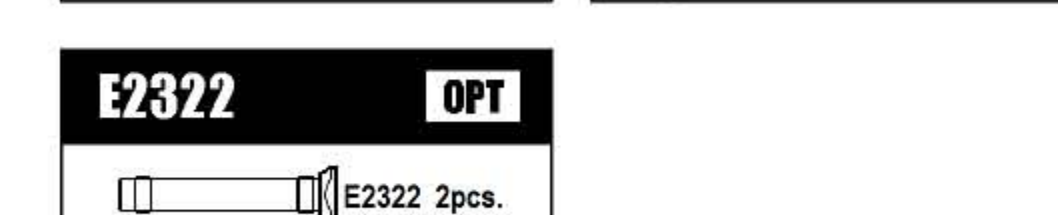
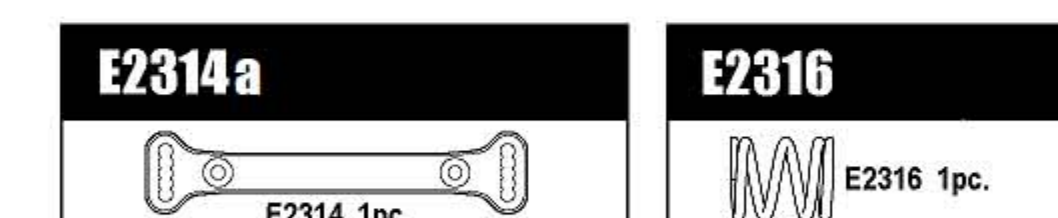
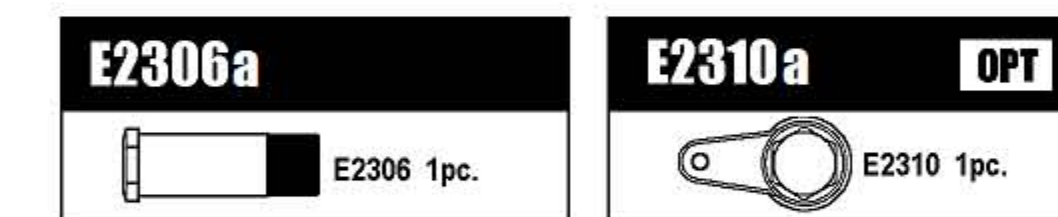
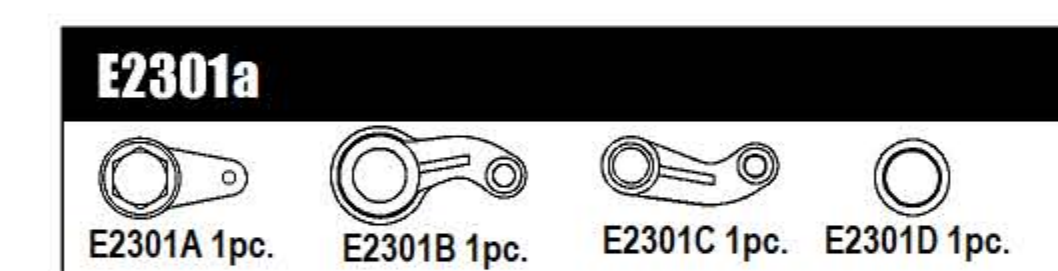
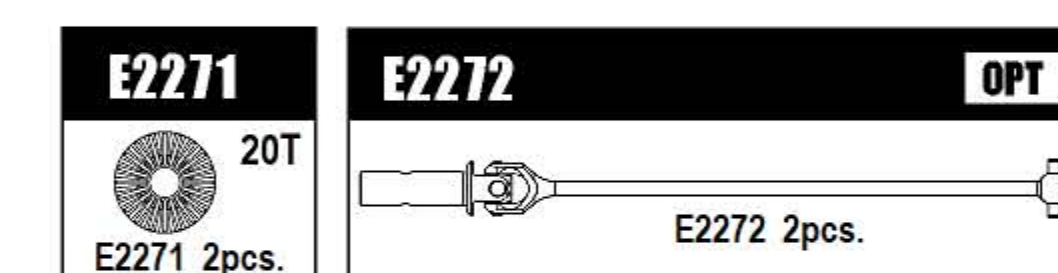
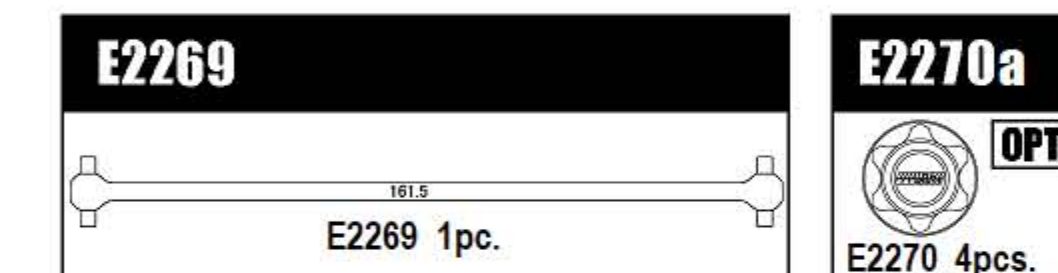
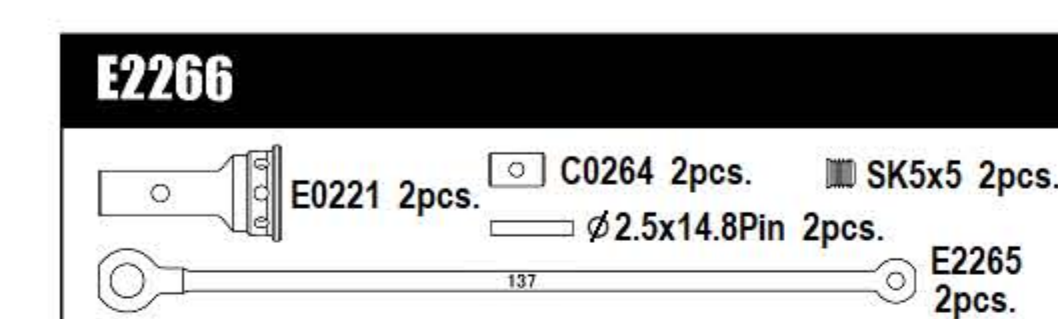
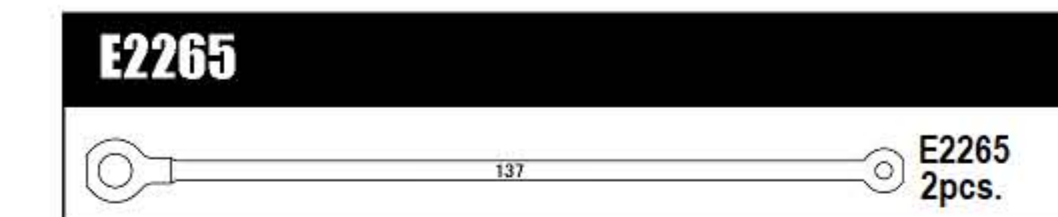
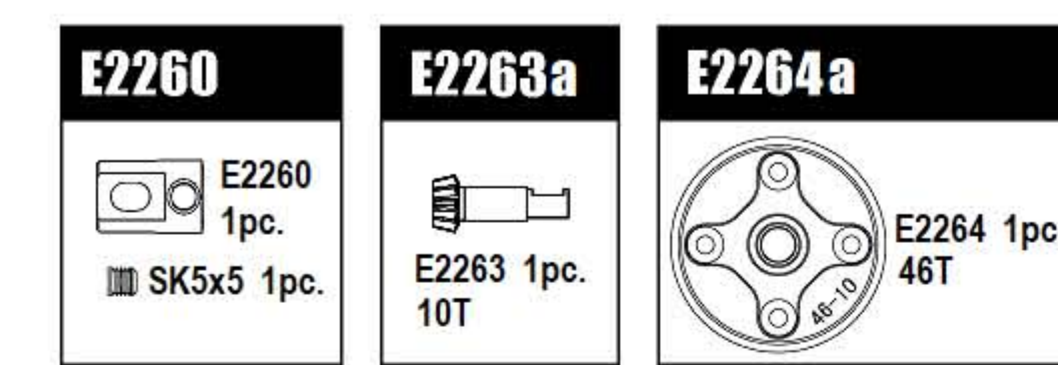
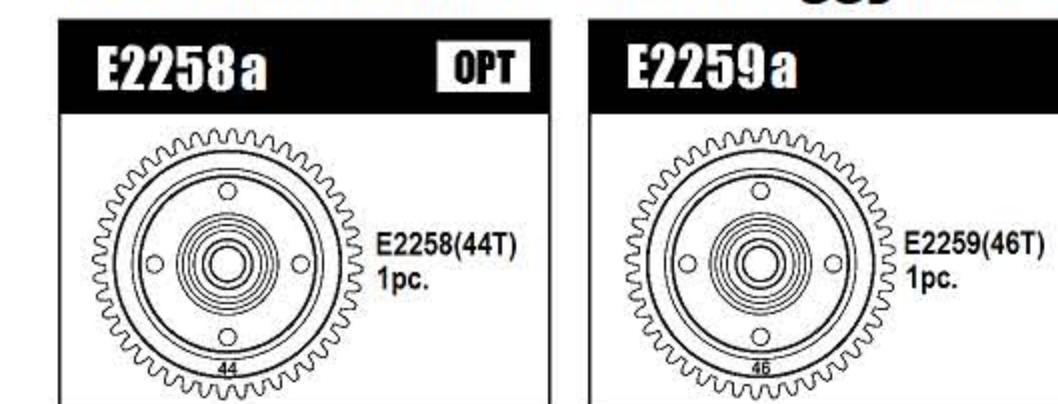

E2258a PLASTIC SPUR GEAR H.T. 44T
 E2259a PLASTIC SPUR GEAR H.T. 46T
 E2260 CENTER JOINT CUP
 E2263a BEVEL GEAR 10T
 E2264a CONICAL GEAR 46T
 E2265 F/R DRIVE SHAFT (137)
 E2266 F/R UNIVERSAL JOINT SET
 E2268 CENTER DRIVE SHAFT (88)
 E2269 CENTER DRIVE SHAFT (161.5)
 E2270a CLOSED WHEEL NUT
 E2271 DIFF. GEAR 20T
 E2272 F/R UNIVERSAL JOINT
 E2301a SERVO SAVER
 E2306a SERVO SAVER PIPE
 E2310a AL. SERVO SAVER ARM
 E2314a STEERING PLATE
 E2316 SERVO SAVER SPRING (HARD)
 E2319 SERVO SAVER SHAFT
 E2320 SERVO SAVER SPRING ADJUSTER
 E2322 SERVO SAVER SHAFT (ALUM)

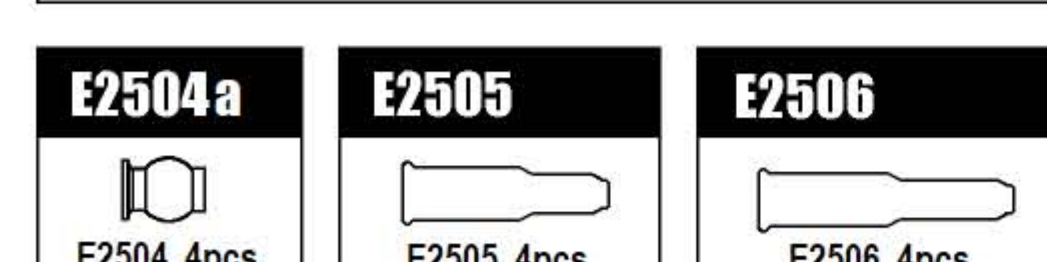
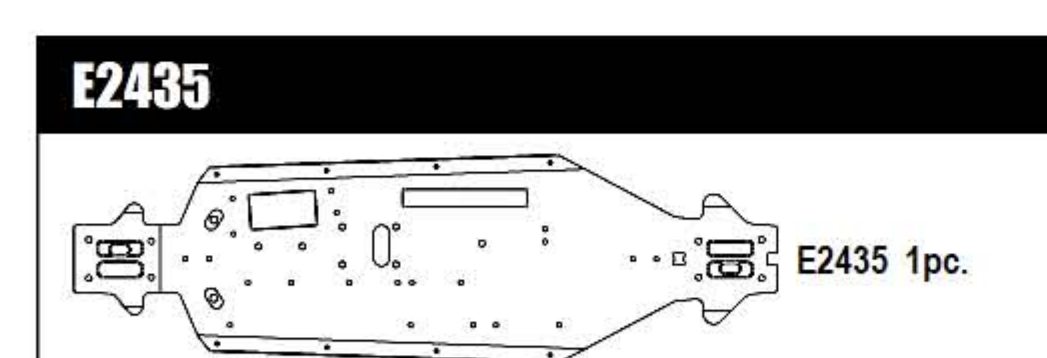
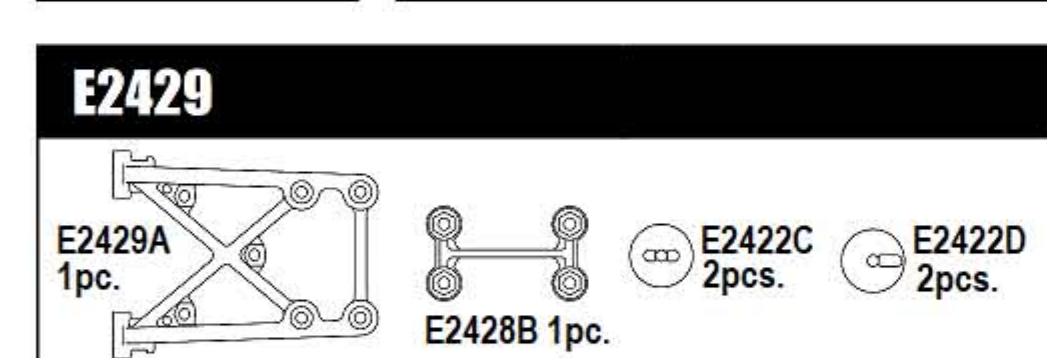
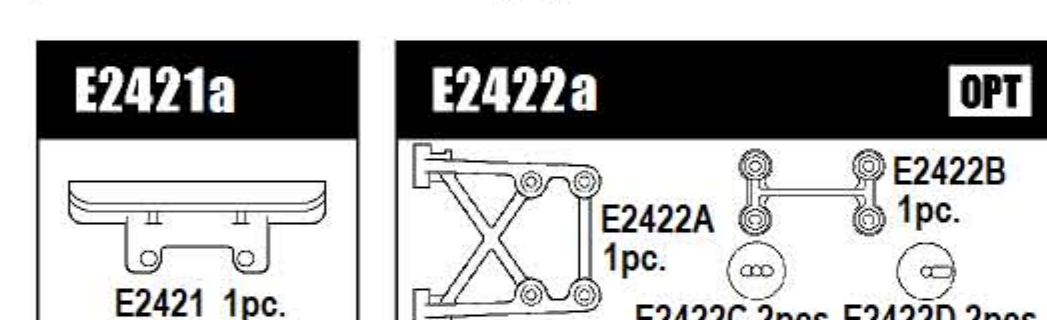
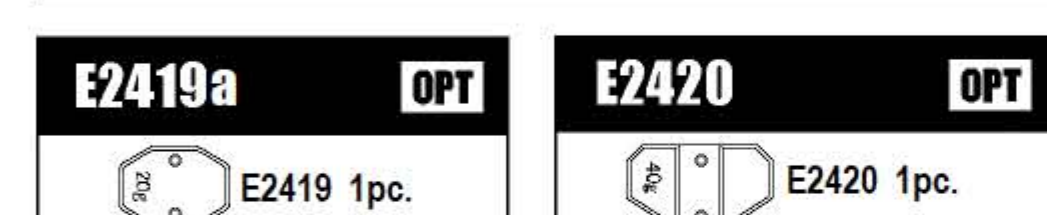
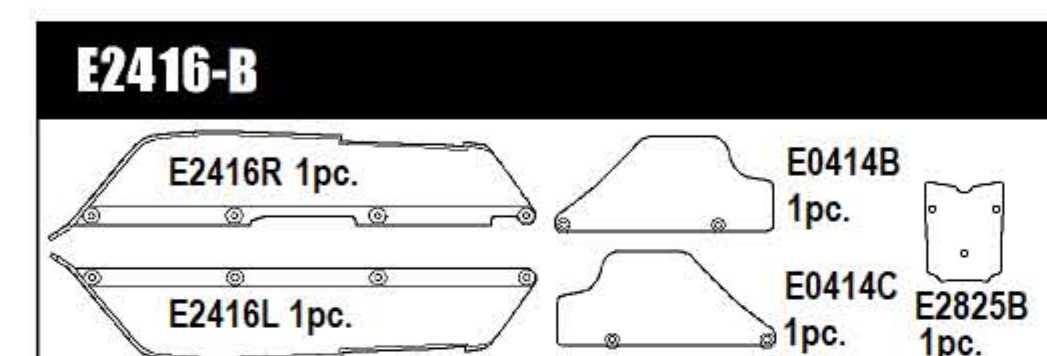
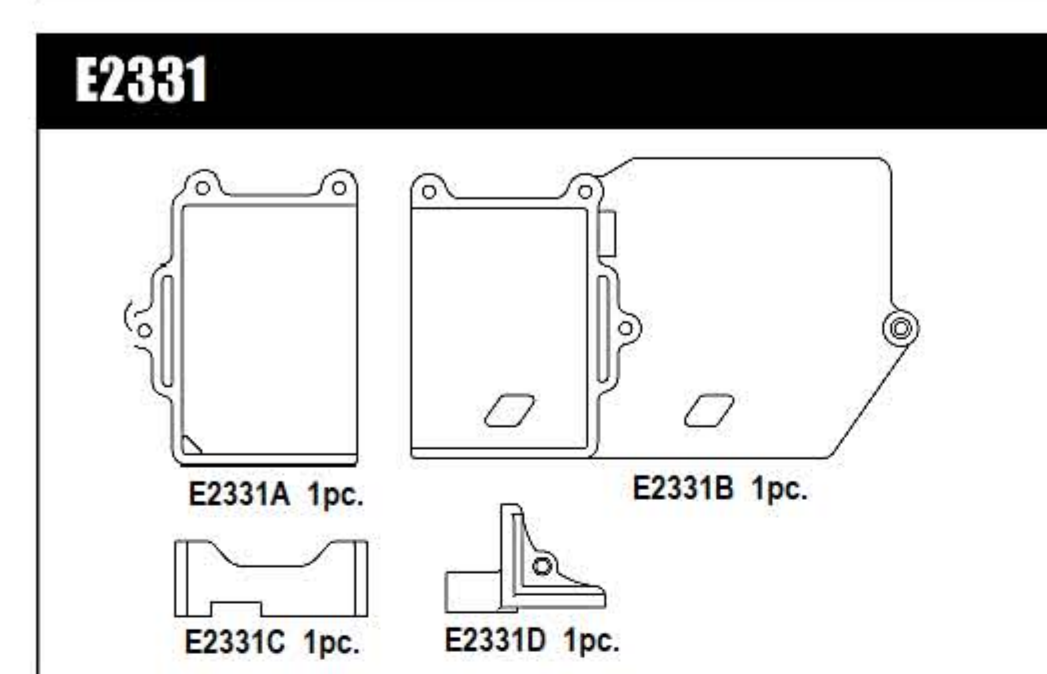
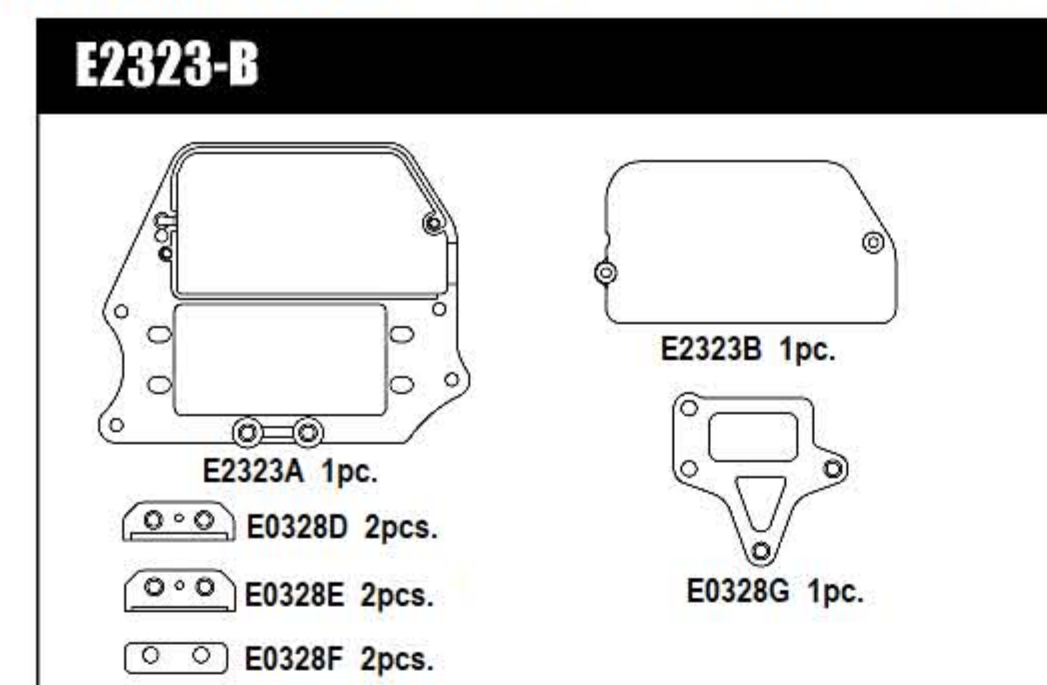

E2323-B SERVO MOUNT & RECEIVER BOX
 E2331 BATTERY HOLDER
 E2416-B STONE GUARD
 E2419a WEIGHT 20g
 E2420 WEIGHT 40g
 E2421a FRONT BUMPER
 E2422a REAR WING STAY
 E2429 REAR WING MOUNT (+15)
 E2430 AL. WING BUTTONS
 E2431 REAR WING MOUNT PLATE CFRP
 E2435 CHASSIS
 E2504a DAMPER END BALL
 E2505 DAMPER BOOTS S
 E2506 DAMPER BOOTS L

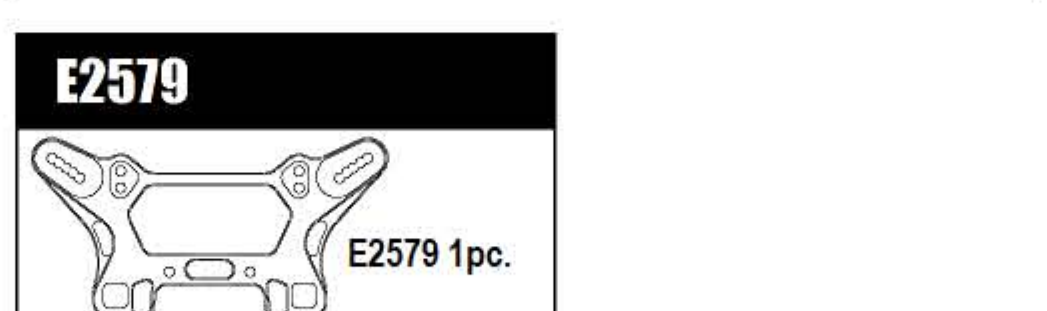
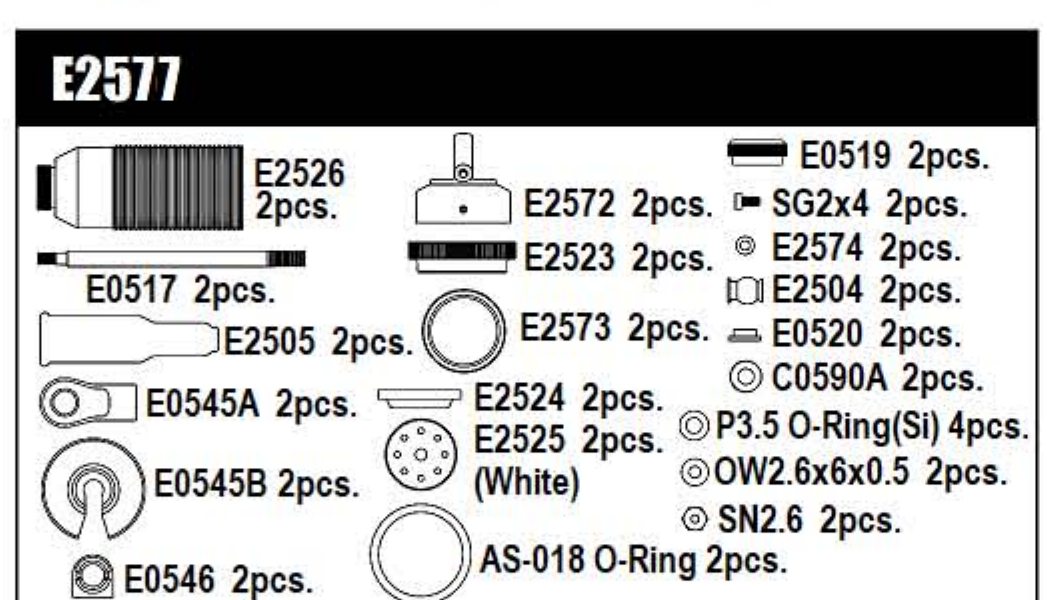
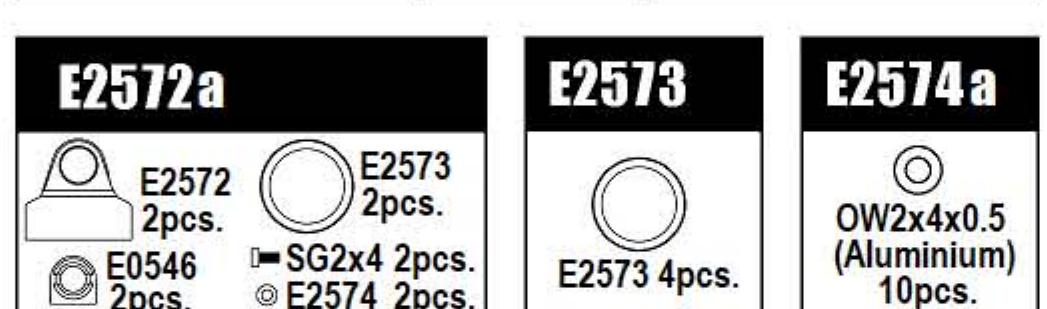
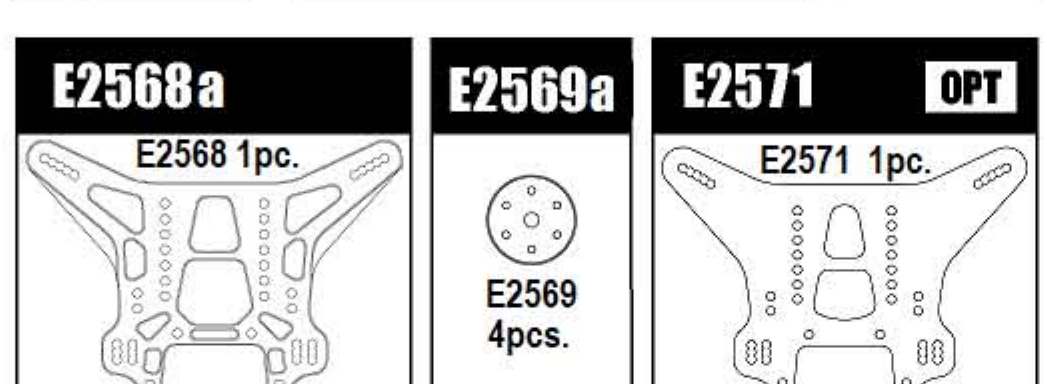
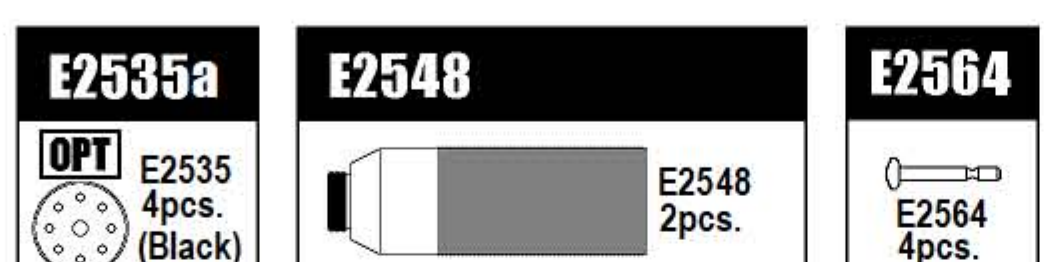
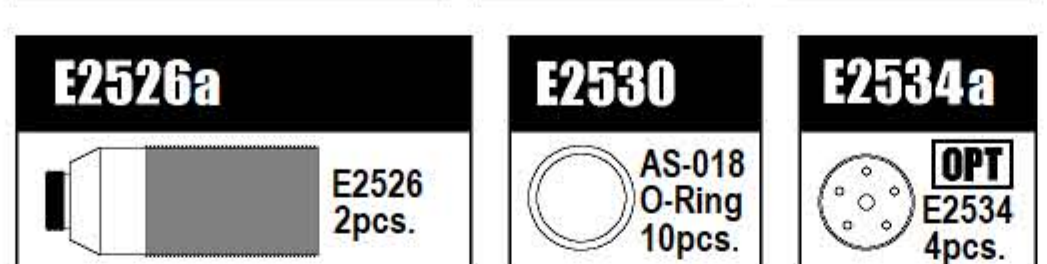
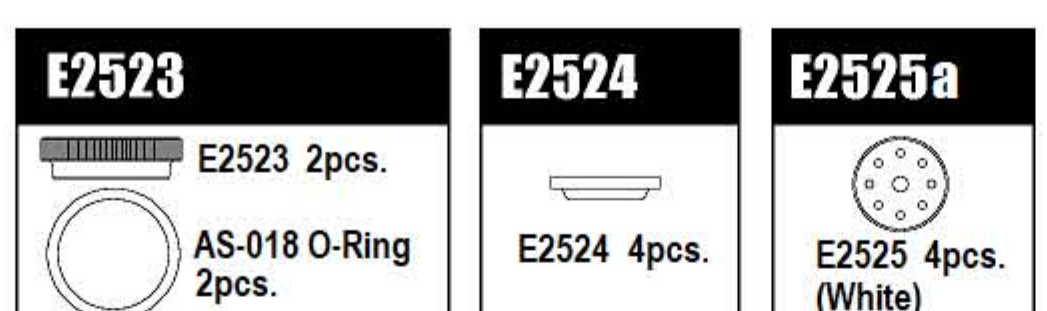
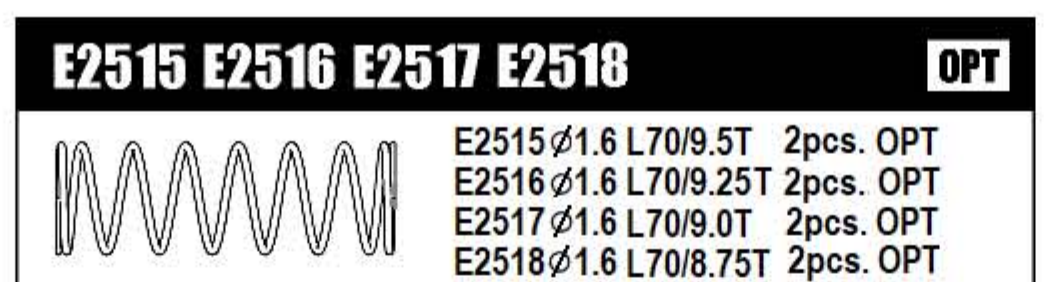
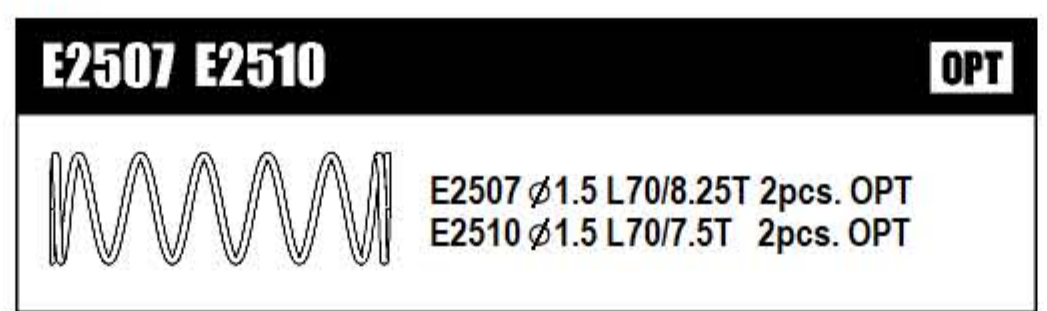

E2507 FRONT DAMPER SPRING ϕ 1.5 L70/8.25T
 E2510 FRONT DAMPER SPRING ϕ 1.5 L70/7.5T
 E2515 FRONT DAMPER SPRING ϕ 1.6 L70/9.5T
 E2516 FRONT DAMPER SPRING ϕ 1.6 L70/9.25T
 E2517 FRONT DAMPER SPRING ϕ 1.6 L70/9.0T
 E2518 FRONT DAMPER SPRING ϕ 1.6 L70/8.75T
 E2523 DAMPER SPRING ADJUSTER
 E2524 DIAPHRAGM
 E2525a DAMPER PISTON (ϕ 1.3/8H)
 E2526a FRONT DAMPER CASE
 E2530 AS-018 O-RINGS
 E2534a DAMPER PISTON (ϕ 1.35/5H)
 E2535a DAMPER PISTON (ϕ 1.2/8H)
 E2548 REAR DAMPER CASE
 E2564 SHOCK PIN
 E2568a REAR DAMPER STAY
 E2569a DAMPER PISTON (ϕ 1.3/6H)
 E2571 REAR DAMPER STAY CFRP
 E2572a EMULSION DAMPER CAP
 E2573 EMULSION DAMPER CAP SEAL
 E2574a OW2x4x0.5 AL. WASHER
 E2577 FRONT SHOCK SET
 E2579 FRONT SHOCK TOWER

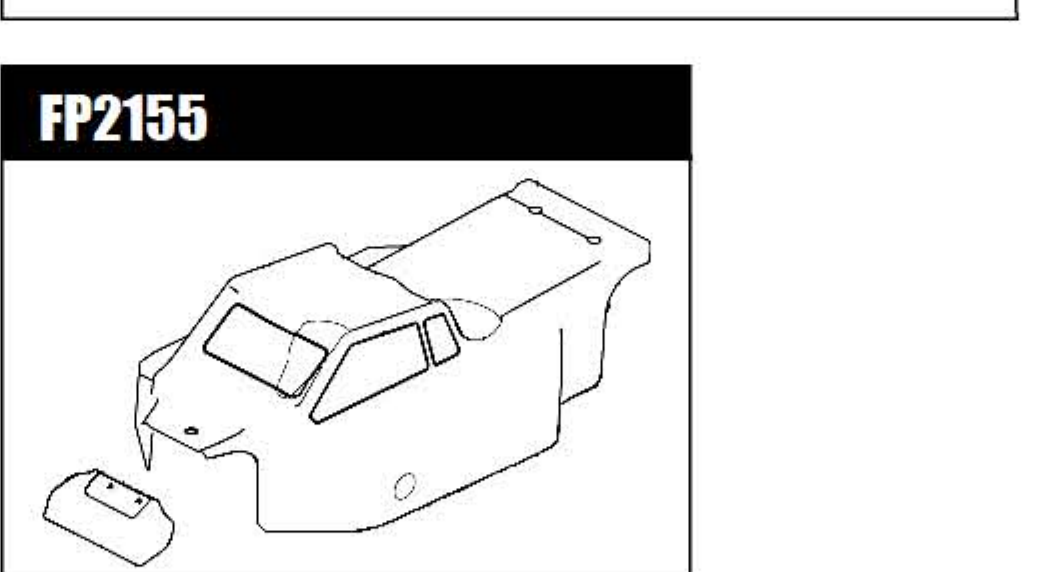
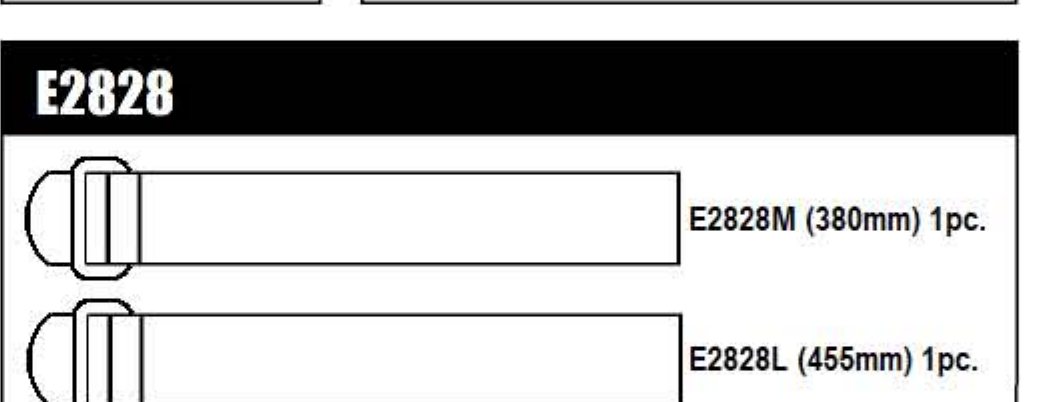
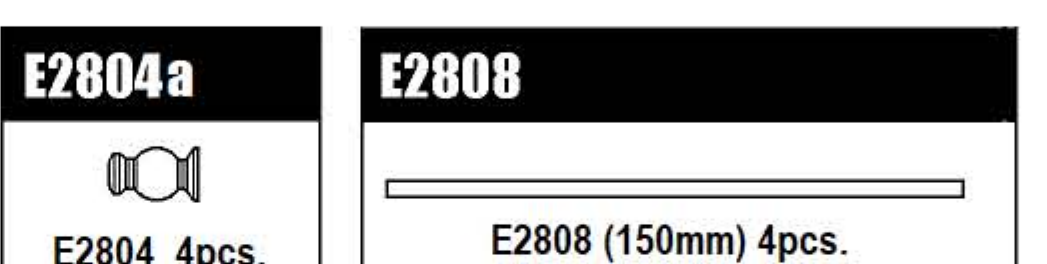
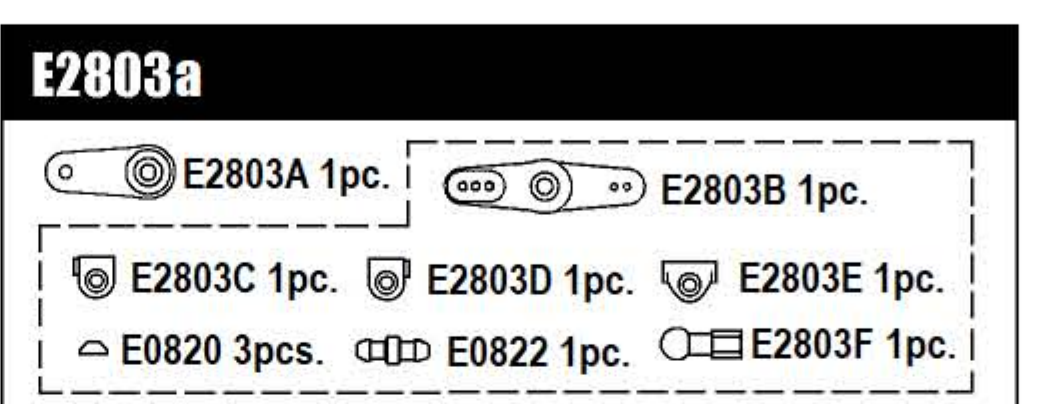
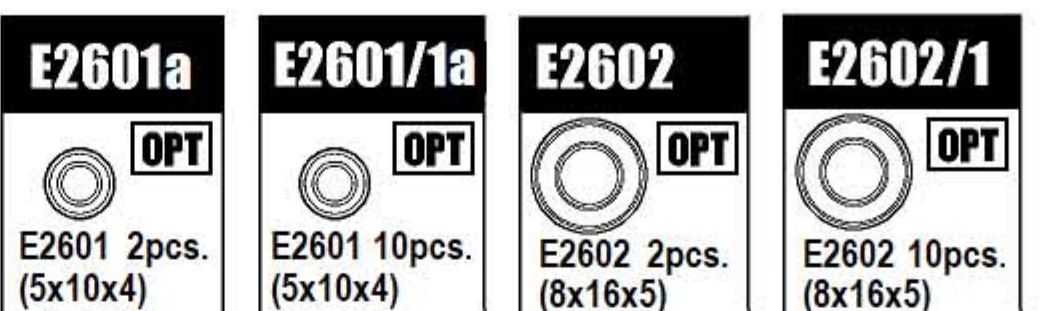
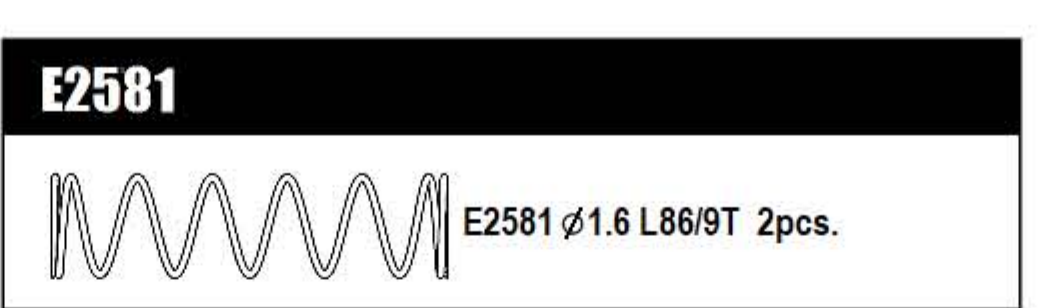
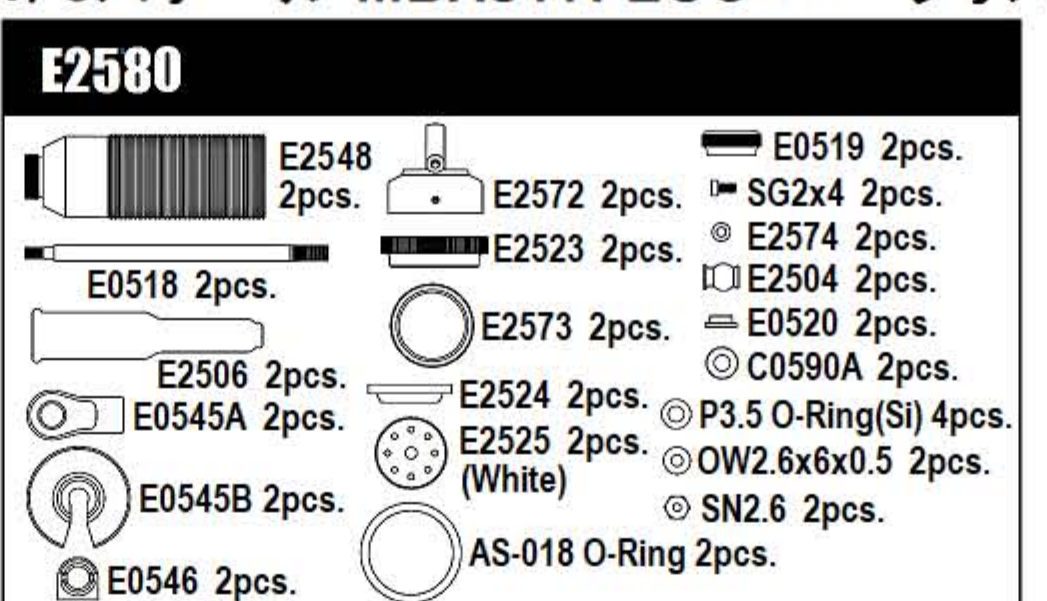

E2580 REAR SHOCK SET
 E2581 REAR SHOCK SPRING ϕ 1.6 L86/9T
 E2601a 5x10x4 NMB BEARINGS (2pcs.)
 E2601/1a 5x10x4 NMB BEARINGS (10pcs.)
 E2602 8x16x5 NMB BEARINGS (2pcs.)
 E2602/1 8x16x5 NMB BEARINGS (10pcs.)
 E2803a SERVO HORN
 E2804a PIVOT BALL
 E2808 ANTENNA PIPE (150mm)
 E2828 BATTERY STRAP SET
 FP2155 FP01 TRUGGY BODY

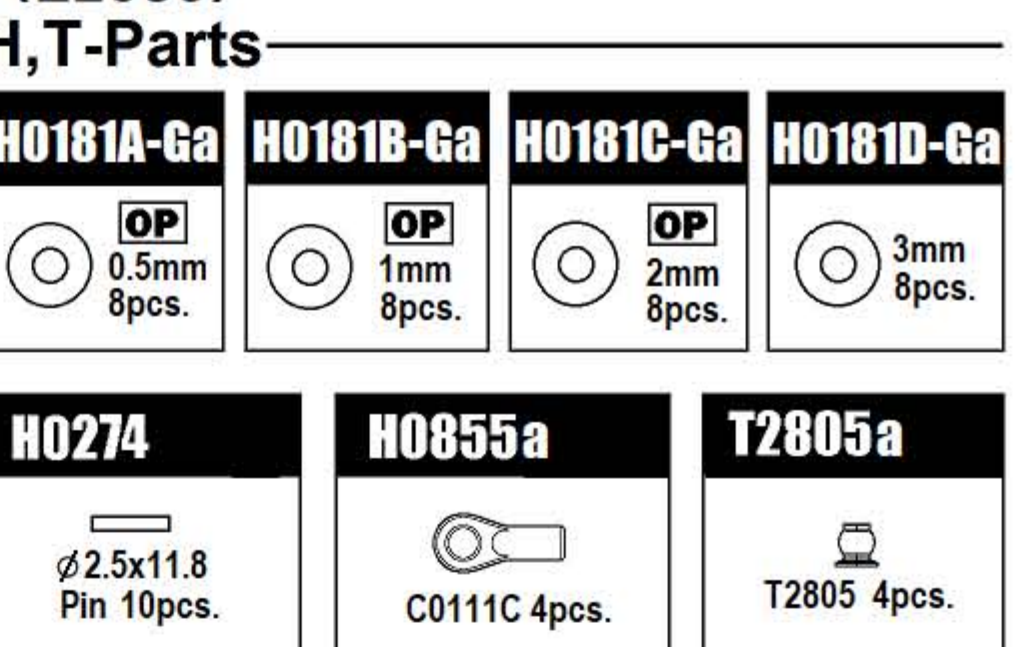

H0181A-Ga 3mm SPACER 0.5mm
 H0181B-Ga 3mm SPACER 1.0mm
 H0181C-Ga 3mm SPACER 2.0mm
 H0181D-Ga 3mm SPACER 3.0mm
 H0274 ROLLER PIN ϕ 2.5x11.8 (10pcs.)
 H0855a BALL LINK ϕ 6mm (C0111C)
 T2805a AL. PIVOT BALL ϕ 6

FP18400a MIP Bypass1 Piston,6H Set,16mm
 FP18410a MIP Bypass1 Piston,8H Set,16mm
 P0402 12 LOGO STICKER
 P0403 12 LOGO STICKER (METALLIC)

MUGEN SEIKI CO., LTD.
 1395 Takane-cho, Funabashi, Chiba 274-0817, Japan
 株式会社 無限精機 千274-0817千葉県船橋市高根町1395
 表示価格はメーカー希望小売価格です。(税別価格)