

1/10th SCALE NITRO STADIUM TRUCK MST-1 PARTS LIST

L0002

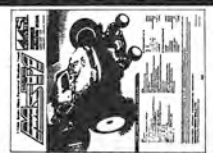

L0003



L0101

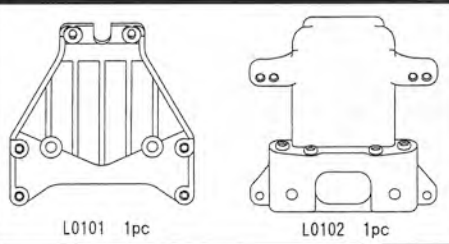

L0103

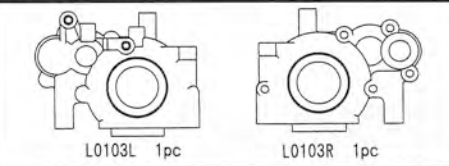

L0104

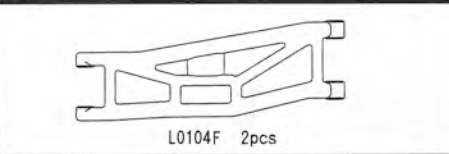

L0105

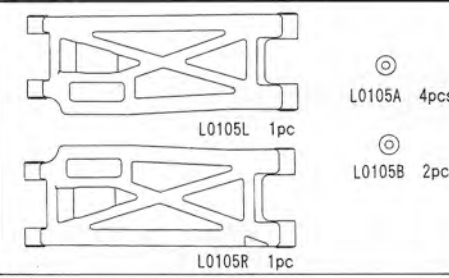

L0106

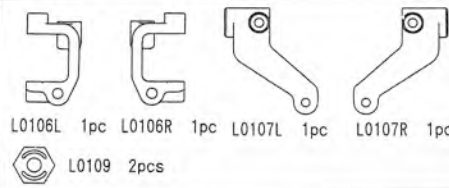

L0110

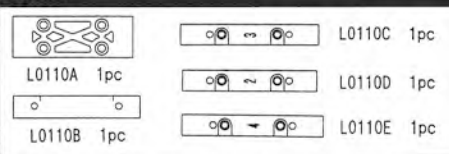

L0112

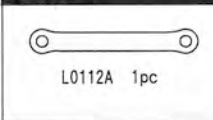

L0113



L0114

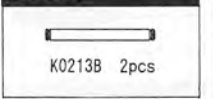

T0114

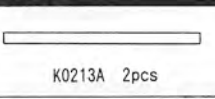

L0115

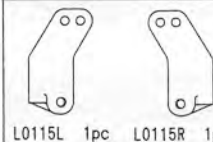

L0116

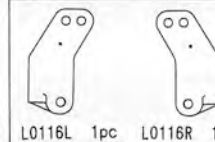

L0117

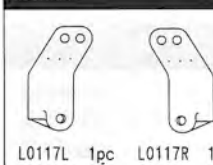

C0126

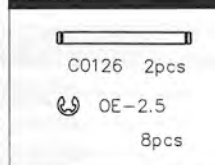

L0201

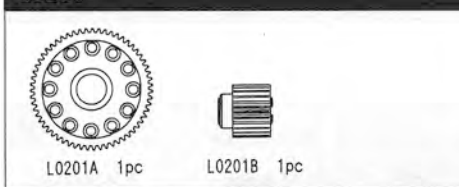

L0202

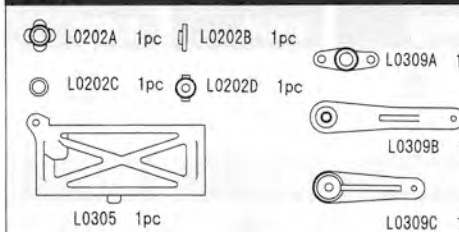

L0203

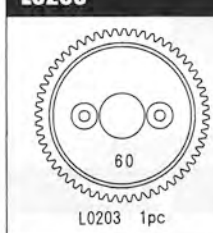

L0204

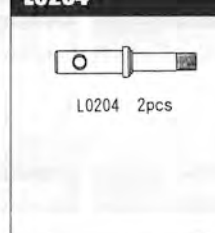

L0205



L0206

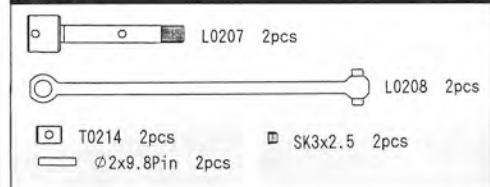

L0207

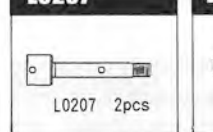

L0208

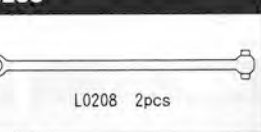

L0211

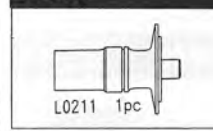

L0212

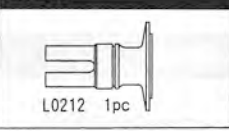

L0213



L0214

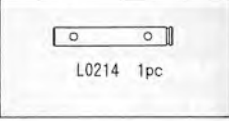

T0214

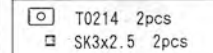

T0215

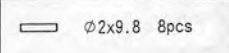

L0215

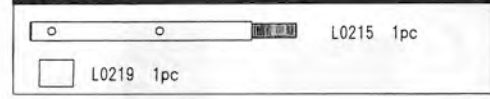

L0216



L0217

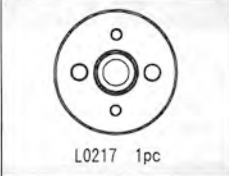

L0218

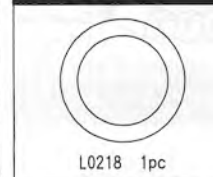

L0220

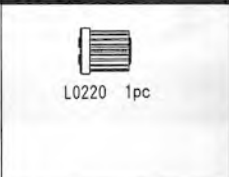

L0221

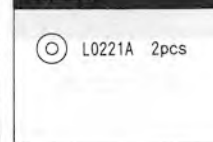

L0222

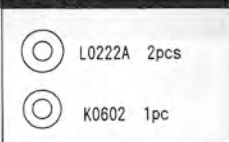



- L0002 INSTRUCTION MANUAL
- L0003 DECAL
- L0101 FRONT CHASSIS
- L0103 GEAR BOX
- L0104 FRONT LOWER ARM
- L0105 REAR LOWER ARM
- L0106 FRONT UPRIGHT
- L0110 LOWER ARM MOUNT

- L0112 FRONT LOWER ARM BRACE
- L0113 REAR BRACE
- L0114 KING PIN
- T0114 REAR LOWER ARM PIN
- L0115 REAR UPRIGHT (2°)
- L0116 REAR UPRIGHT (1°)
- L0117 REAR UPRIGHT (3°)
- C0126 UPPER ARM SHAFT
- L0201 BALL DIFF. GEAR
- L0202 BRAKE PARTS
- L0203 SPUR GEAR (60T)
- L0204 FRONT AXLE SHAFT
- L0205 BEARING SPACER

- L0206 REAR UNIVERSAL SHAFT SET
- L0207 REAR UNIVERSAL AXLE SHAFT
- L0208 REAR UNIVERSAL DRIVE SHAFT
- L0211 DIFF. OUT DRIVE L
- L0212 DIFF. OUT DRIVE R
- L0213 DIFF. RING
- L0214 IDLER SHAFT
- T0214 JOINT SHAFT FOR UNIVERSAL
- T0215 JOINT PIN FOR UNIVERSAL
- L0215 SLIPPER SHAFT
- L0216 SLIPPER PLATE A
- L0217 SLIPPER PLATE B
- L0218 SLIPPER PAD
- L0220 COUNTER GEAR

L0223  L0223 1pc



L0224  L0224 1pc

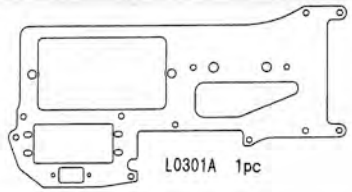

L0225  3/32inch Ball 14pcs

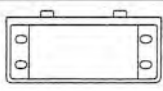

L0226  5/64inch Ball 8pcs

L0301  L0301A 1pc

L0302  L0302A 1pc

 L0302B 2pcs  L0302C 2pcs

 L0302D 2pcs  L0302E 2pcs

 L0302F 2pcs  L0302G 2pcs

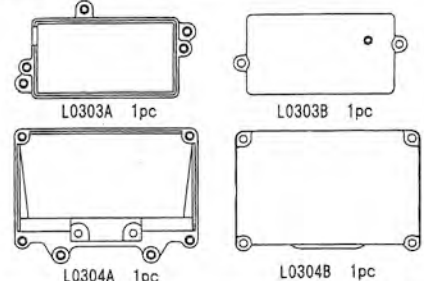
L0303 

L0303A 1pc L0303B 1pc

L0304A 1pc L0304B 1pc

L0306 

L0306A 1pc L0306B 1pc L0306C 1pc L0306D 1pc

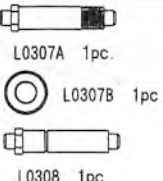
L0307 

L0307A 1pc L0307B 1pc L0308 1pc

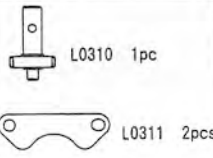
L0310 



L0310 1pc L0311 2pcs

L0312  L0312 1pc

L0313  L0313 1pc

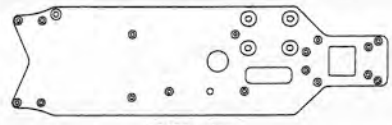
H0368  H0368 10pcs

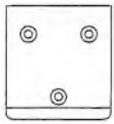
L0401  L0401 1pc

L0402  L0402A 1pc  L0402B 2pcs

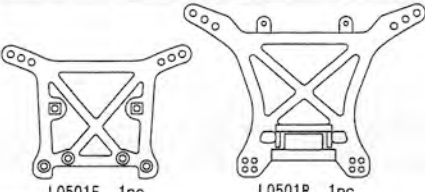
L0501 

L0501F 1pc L0501R 1pc

L0502  L0502A 4pcs  L0502C 4pcs

 L0502B 4pcs  L0502D 4pcs

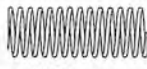
L0503  L0503 2pcs

L0504  L0504 2pcs

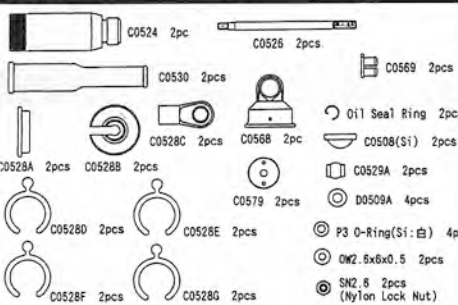
L0505 

C0524 2pc C0526 2pcs C0569 2pcs

C0530 2pcs C0528C 2pcs C0568 2pc Oil Seal Ring 2pcs

C0528A 2pcs C0528B 2pcs C0528E 2pcs C0528F 2pcs C0528G 2pcs

C0529A(Si) 2pcs C0529A 2pcs D0509A 4pcs

P3 O-Ring(Si:白) 4pcs

OW2.5x6x0.5 2pcs

SN2.6 2pcs (Nylon Lock Nut)

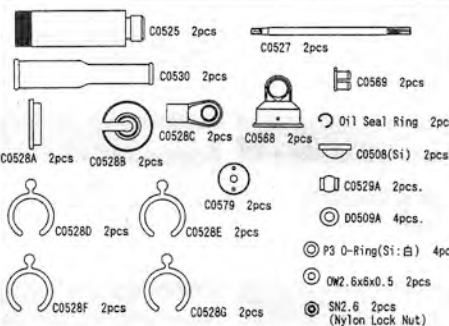
L0506 

C0525 2pcs C0527 2pcs C0568 2pcs

C0530 2pcs C0528C 2pcs C0568 2pcs Oil Seal Ring 2pcs

C0528A 2pcs C0528B 2pcs C0528E 2pcs C0528F 2pcs C0528G 2pcs

C0529A(Si) 2pcs C0529A 2pcs D0509A 4pcs

P3 O-Ring(Si:白) 4pcs

OW2.5x6x0.5 2pcs

SN2.6 2pcs (Nylon Lock Nut)

C0508  C0508 8pcs

D0509  D0509A 8pcs

P3 O-Ring 8pcs

OIL SEAL RING 4pcs

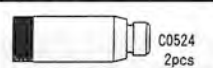
C0524  C0524 2pcs

C0525  C0525 2pcs

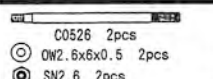
C0526 

C0526 2pcs

OW2.5x6x0.5 2pcs

SN2.6 2pcs

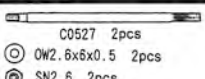
C0527 

C0527 2pcs

OW2.5x6x0.5 2pcs

SN2.6 2pcs

C0528 

C0528C 2pcs C0528A 2pcs

C0528B 2pcs C0528D,E,F,G *2pcs

C0529A  C0529A 4pcs

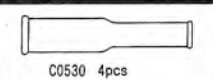
C0530  C0530 4pcs

C0568  C0568 2pcs

C0569  C0569 4pcs

C0579  C0579 4pcs

- L0221 DIFF. THRUST WASHER
- L0222 SLIPPER THRUST WASHER
- L0223 SLIPPER SPRING
- L0224 BALL DIFF. SPRING
- L0225 3/32 INCH BALL
- L0226 5/64 INCH BALL
- L0301 RADIO PLATE
- L0302 SERVO MOUNT PARTS
- L0303 RECEIVER & BATTERY PARTS
- L0306 SERVO SAVER ARM
- L0307 SERVO SAVER SHAFT
- L0310 BRAKE CAM & PLATE

- L0312 BRAKE DISK
- L0313 SERVO SAVER SPRING
- H0368 GROMMET
- L0401 CHASSIS
- L0402 FRONT BUMPER
- L0501 DAMPER STAY
- L0502 DAMPER PIVOT
- L0503 FRONT SPRING
- L0504 REAR SPRING
- L0505 FRONT DAMPER SET

- L0506 REAR DAMPER SET
- C0508 DIAPHRAGM
- D0509 O-RING SET
- C0524 FRONT DAMPER CASE
- C0525 REAR DAMPER CASE
- C0526 FRONT DAMPER SHAFT
- C0527 REAR DAMPER SHAFT
- C0528 DAMPER PLASTIC PARTS
- C0529A LINK BALL (4pcs.)
- C0530 DUST RUBBER
- C0568 DAMPER CAP
- C0569 DAMPER CAP BUSH
- C0579 DAMPER PISTON

1/10th SCALE NITRO STADIUM TRUCKMST-1 PARTS LIST

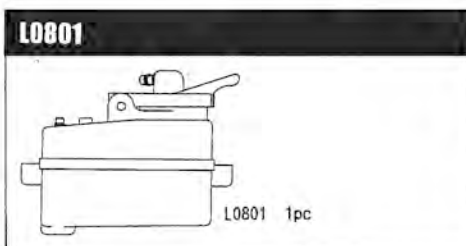
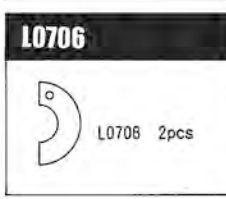
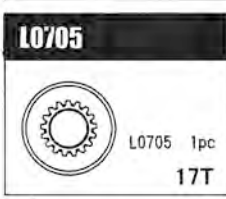
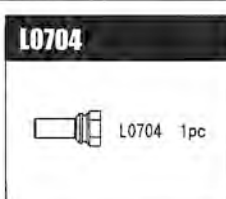
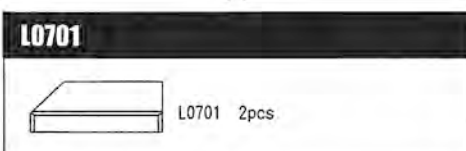

- H0601 BEARING 12X18X4
- L0601 BEARING 3/16X3/8
- C0602 BEARING 5X8X2.5
- K0602 BUSH 5X11X4
- C0603 BEARING 5X10
- H0603 BALL BEARING FOR BELT TENSIONER
- L0701 ENGINE MOUNT
- L0703 FLYWHEEL
- L0704 ENGINE NUT
- L0705 CLUTCH BELL (17T)
- L0706 CLUTCH SHOE
- L0707 CLUTCH SPRING
- L0801 FUEL TANK
- L0802 BALL END
- L0803 PIVOT BALL

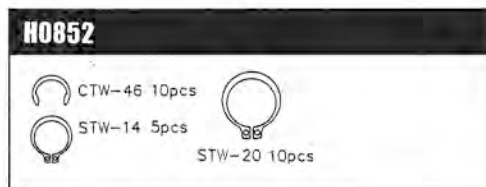
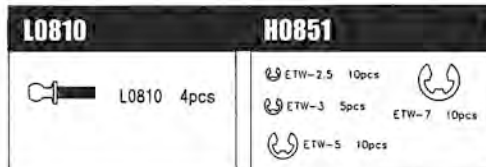
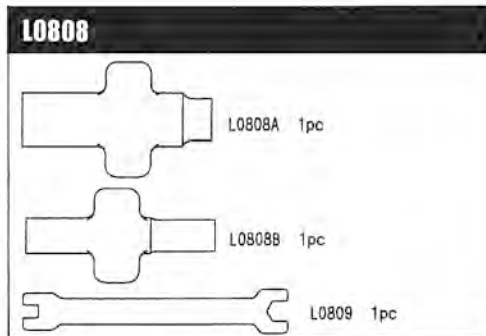
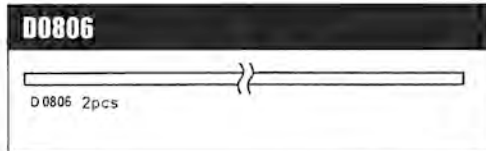
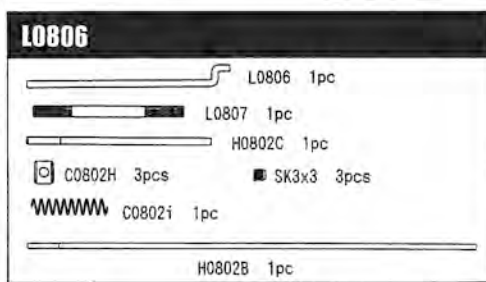
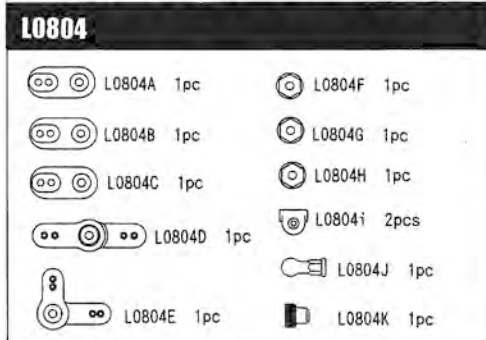

- L0804 SERVO HORN
- L0805 STEERING ROD
- L0806 LINKAGE SET
- D0806 ANTENNA PIPE
- L0808 TOOL SET
- L0810 PIVOT BALL (LONG)
- H0851 E-RING SET
- H0852 SNAP RING SET

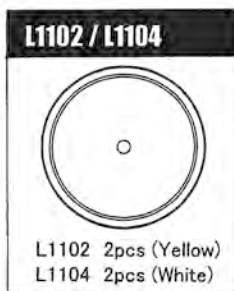
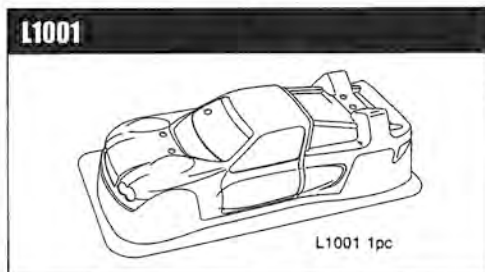
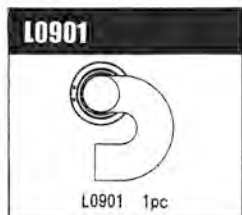

- C0901 MUFFLER STAY
- L0901 MANIFOLD
- T0902 MANIFOLD SPRING
- L1001 MST-1 BODY
- L1101 FRONT WHEEL (YELLOW)
- L1102 REAR WHEEL (YELLOW)
- L1103 FRONT WHEEL (WHITE)
- L1104 REAR WHEEL (WHITE)

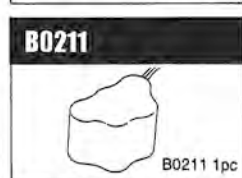
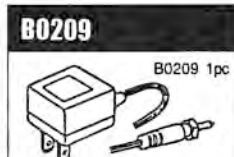
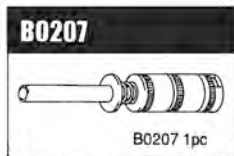
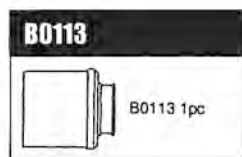

B0215 B0216 B0215 1pc B0216 1pc	B0217 B0218 B0217 1pc B0218 1pc
B0220 B0220 1pc	B0301 B0301 1pc
B0302 B0302 1pc	B0303 B0303 1pc
B0306 B0306 1pc	B0308 B0308 1pc
B0310 B0316 B0311 B0325 B0312 B0326 B0313 B0327 B0314 B0328 B0315	 B0310 1pc B0316 1pc B0311 1pc B0325 1pc B0312 1pc B0326 1pc B0313 1pc B0327 1pc B0314 1pc B0328 1pc B0315 1pc
B0329 B0329 1pc	B0330 B0330 1pc
B0406 B0406 2pcs	B0407 B0407 15pcs
B0408 B0408 15pcs	
B0410 B0411 B0412 B0410 Pink 1pc B0411 Green 1pc B0412 Yellow 1pc	B0415 Pink 1pc Green 1pc Yellow 1pc
B0416 100% 18pcs	B0417 150% 18pcs
B0422 B0422 8pcs	B0508 B0508 1pc
B0509 B0509 1pc	B0510 B0510 1pc
B0519 B0519 1pc	B0520 B0520 1pc
(+) #2	(+) #1

B0521 (-) 1.0 B0521 1pc	B0522 (-) 0.5 B0522 1pc
B0523 1.5mm Hex. B0523 1pc	B0524 2.0mm Hex. B0524 1pc
B0525 2.5mm Hex. B0525 1pc	B0526 3.0mm Hex. B0526 1pc
B0527 2.0mm Ball-Hex. B0527 1pc	B0528 2.5mm Ball-Hex. B0528 1pc
B0529 B0529 10pcs	
B0645 SJA4x8	B0652 Si2x8
B0663 SG3x12	
B0670 SK3x3	B0674 SK3x2.6
B0681 SK4x5	
B0710 SN3	B0712 SN2.6
B0713 SN3	
B0714 SN4	B0715 10/32 inch Nut
B0730 SiG3x8	B0731 SiG3x10
B0732 SiG3x12	
B0733 SiG3x14	B0734 SiG3x16
B0735 SiG3x18	
B0736 SiG3x6	B0737 SiG3x20
B0738 SiG3x25	B0740 SJG3x8
B0741 SJG3x10	

- B0113 AIR FILTER FOR 21 ON-ROAD
- B0115 FUEL PUMP 500ml
- B0203 QUICK BOOSTER
- B0207 POCKET BOOSTER
- B0208 ADAPTER FOR POCKET BOOSTER
- B0209 BATTERY FOR POCKET BOOSTER
- B0211 POWER PACK 900 W/FUTABA 2+3
- B0212 POWER PACK 900 W/SANWA 2+3
- B0215 POWER PACK 650 W/FUTABA 2+3
- B0216 POWER PACK 650 W/SANWA 2+3
- B0217 POWER PACE 730 W/FUTABA 2+3
- B0218 POWER PACK 730 W/SANWA 2+3
- B0220 PRO STARTER RII
- B0301 LOCK FIRM LIQUID
- B0302 AIR FILTER OIL
- B0303 ENGINE MAINTENANCE OIL
- B0306 RAD REZ
- B0308 SUPER GREASE
- B0310 SUPER SILICON #100
- B0311 SUPER SILICON #150
- B0312 SUPER SILICON #200
- B0313 SUPER SILICON #250
- B0314 SUPER SILICON #300
- B0315 SUPER SILICON #350
- B0316 SUPER SILICON #400
- B0325 SUPER SILICON #500
- B0326 SUPER SILICON #600
- B0327 SUPER SILICON #700
- B0328 SUPER SILICON #800
- B0329 AIR FILTER OIL
- B0330 SUPER JOINT GREASE
- B0406 BOTH SIDE TAPE
- B0407 FLATE WASHER 3mm
- B0408 FLATE WASHER 4mm
- B0410 COLOR SILICON PIPE PINK
- B0411 COLOR SILICON PIPE GREEN
- B0412 COLOR SILICON PIPE YELLOW
- B0415 MUFFLER JOINT SILICON PIPE S
- B0416 COLOR STRAP SET 100mm
- B0417 COLOR STRAP SET 150mm
- B0422 BODY PIN
- B0508 UTILITY WRENCH
- B0509 SETTING DRIVER FOR ENGINE
- B0510 CAMBER GAUGE
- B0519 (+) #2 SCREW DRIVER
- B0520 (+) #1 SCREW DRIVER
- B0521 (-) 1.0 SCREW DRIVER
- B0522 (-) 0.5 SCREW DRIVER
- B0523 1.5mm Hex. WRENCH
- B0524 2.0mm Hex. WRENCH
- B0525 2.5mm Hex. WRENCH
- B0526 3.0mm Hex. WRENCH
- B0527 2.0mm Ball-Hex. WRENCH
- B0528 2.5mm Ball-Hex. WRENCH
- B0529 PRO SPEC TOOL SET
- B0645 SJA4X8 F/H SCREW
- B0652 SI2X8 R/H SCREW
- B0663 SG3X12 CAP SCREW
- B0670 SK3X3 SET SCREW
- B0674 SK3X2.6 SET SCREW
- B0681 SK4X5 SET SCREW
- B0710 SN3 NUT
- B0712 SN2.6 NYLON NUT
- B0713 SN3 NYLON NUT (10pcs)
- B0714 SN4 NYLON NUT (10pcs)
- B0715 10/32 INCH NUT
- B0730 SiG3X8 B/H SCREW
- B0731 SiG3X10 B/H SCREW
- B0732 SiG3X12 B/H SCREW
- B0733 SiG3X14 B/H SCREW
- B0734 SiG3X16 B/H SCREW
- B0735 SiG3X18 B/H SCREW
- B0736 SiG3X6 B/H SCREW
- B0737 SiG3X20 B/H SCREW
- B0738 SiG3X25 B/H SCREW
- B0740 SJG3X8 F/H SCREW
- B0741 SJG3X10 F/H SCREW