

# 1/10 th SCALE 4WD GAS POWERED TOURING CAR MTX-2 PARTS LIST

## H0551

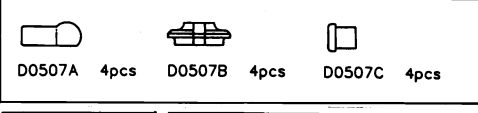

## H0601



## D0602

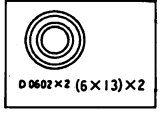

## C0603

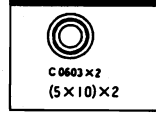

## H0603 OPT



## K0603



## K0603/1 OPT



## D0701

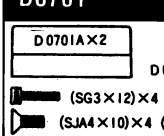

## T0701 OPT

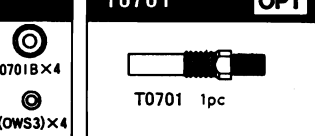

## T0702

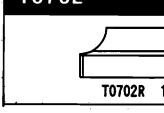

## T0702L OPT

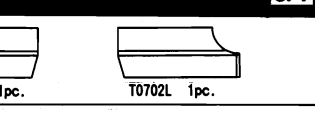

## D0703

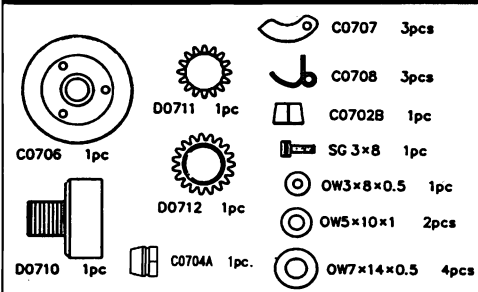

## C0704

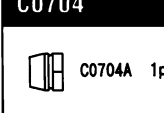

## T0704 OPT

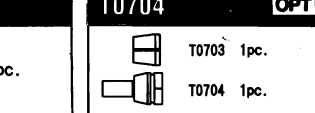

## C0706

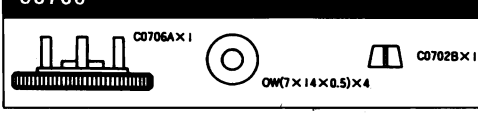

## C0707

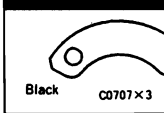

## C0708

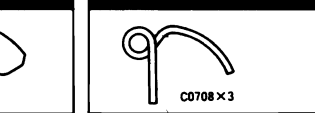

## C0710

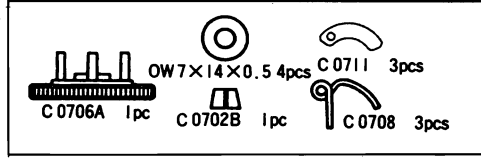

## C0711 OPT

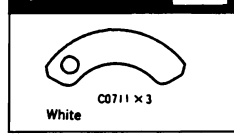

## D0710

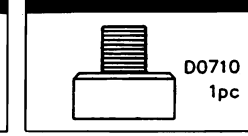

## D0711

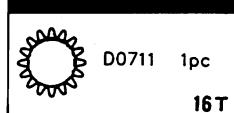

## D0712



## D0713 OPT

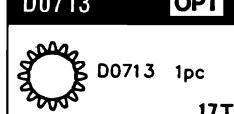

## D0714 OPT

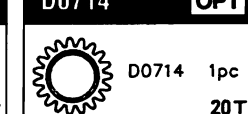

## C0723

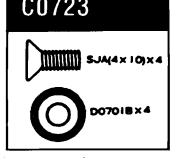

## C0751 OPT

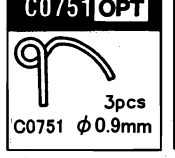

## C0753 OPT

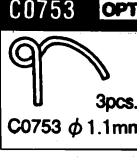

## T0801

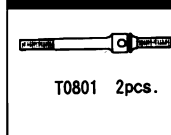

## T0802

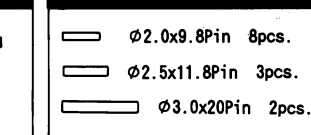

## H0802

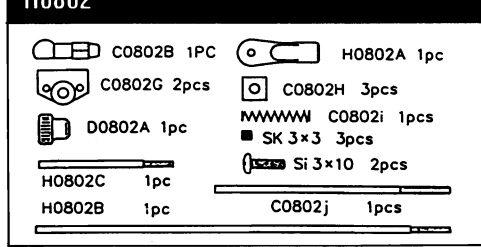

## D0803

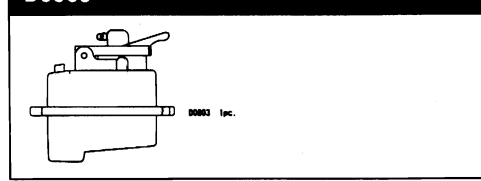

## D0806

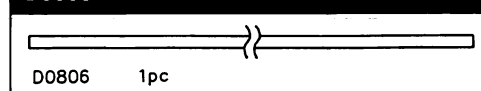

## D0809

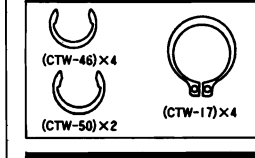

## H0851

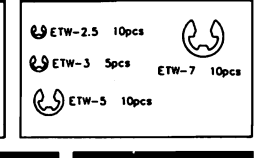

## H0852

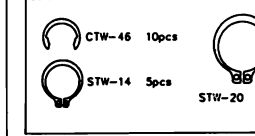

## H0855

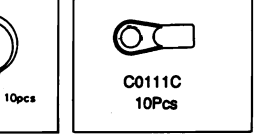

## H0856 OPT

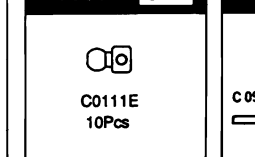

## C0901

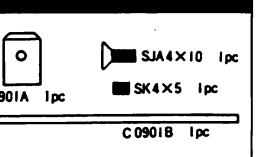

## T0901

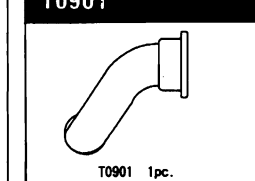

## T0902

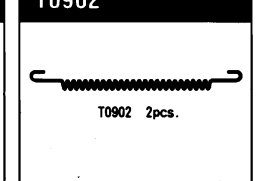

## T0903 OPT

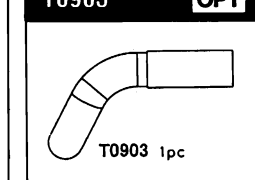

- H0551 DAMPER PLASTIC PARTS
- H0601 BEARING
- D0602 BEARINGS (6X13)
- C0603 BEARINGS (5X10)
- H0603 BALL BEARING FOR BELT TENSIONER
- K0603 BEARINGS (10X15x4)
- K0603/1 BEARINGS 10pcs. (10x15x4)
- D0701 ENGINE MOUNT
- T0701 ENGINE SHAFT FOR NOVAROSSO CX12
- T0702 AL. ENGINE MOUNT
- D0703 3P CLUTCH SET
- C0704 ENGINE NUT
- T0704 ENGINE NUT (FOR OS)
- C0706 FLYWHEEL FOR 3P CLUTCH
- C0707 CARBON CLUTCH SHOE
- C0708 CLUTCH SPRING

- C0710 3P CLUTCH SET
- C0711 3P CLUTCH SHOE (WHITE)
- D0710 CLUTCH BELL
- D0711 1ST. GEAR 16T
- D0712 2ND. GEAR 19T
- D0713 1ST. GEAR 17T
- D0714 2ND. GEAR 20T
- C0723 ENGINE MOUNT FLAT SCREW
- C0751 CLUTCH SPRING φ 0.9mm
- C0753 CLUTCH SPRING φ 1.1mm
- T0801 STEERING ROD
- H0802 ENCON LINKAGE
- T0802 ROLLER PIN SET
- D0803 FUEL TANK
- D0806 ANTENNA PIPE

- D0809 C-RING SET
- H0851 E-RING SET
- H0852 SNAP RING SET
- H0855 BALL LINK 6mm
- H0856 STABILIZER LINK BALL
- C0901 MUFFLER STAY
- T0901 MANIFOLD
- T0902 MANIFOLD SPRING
- T0903 MANIFOLD FOR SIDE EXHAUST
- K1111/1 MESH WHEELS WHITE (8pcs.)
- K1111 MESH WHEELS WHITE
- K1112 MESH WHEELS BLACK
- K1113 MESH WHEELS SILVER
- K1114 6 SPOKE WHEELS WHITE
- K1115 6 SPOKE WHEELS GOLD
- K1116 6 SPOKE WHEELS GREEN
- K1117 FIN-TYPE WHEELS WHITE
- K1118 FIN-TYPE WHEELS SILVER
- K1120 SLICK TIRES & INNER FOAM
- K1122 RADIAL TIRES & INNER FOAM
- K1123 INNER FOAM (RING TYPE/4pcs.)
- K1124 INNER FOAM HARD (RING TYPE/4pcs.)
- K1130 6 SPOKE WHEELS WHITE (4pcs.)
- K1131 6 SPOKE WHEELS WHITE (8pcs.)

# MTX-2 パーツリスト

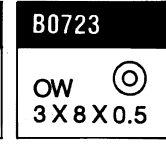
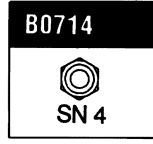
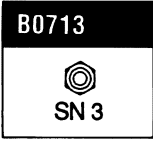
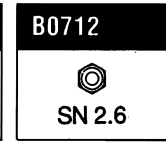
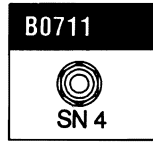
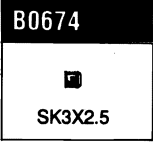
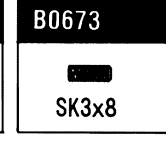
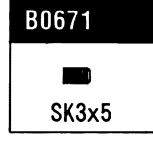
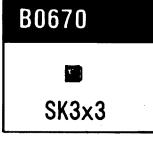
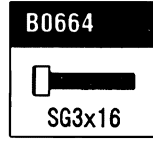
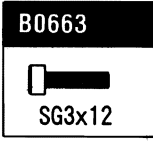
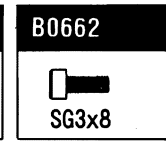
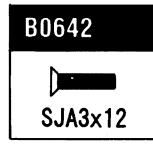
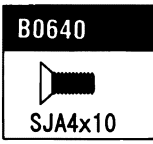
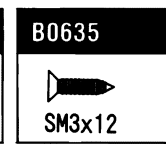
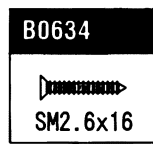
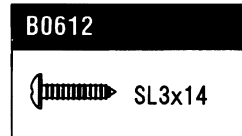
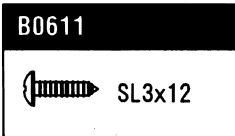
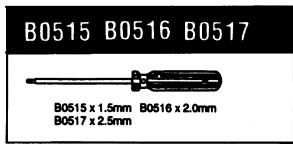
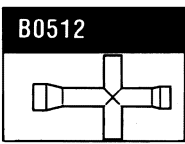
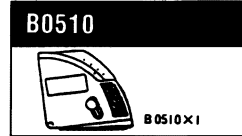
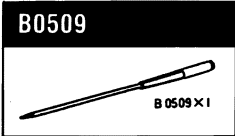
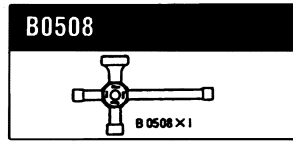
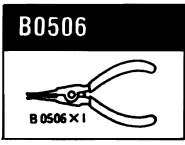
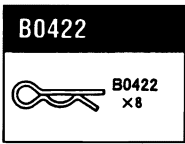
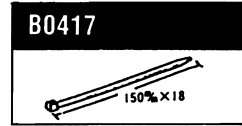
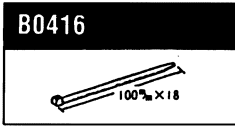
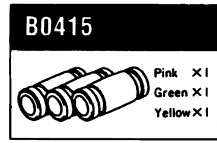
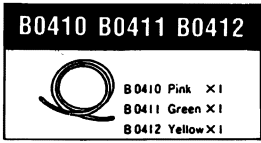
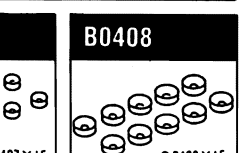
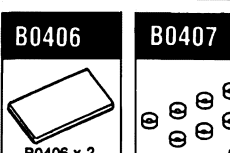
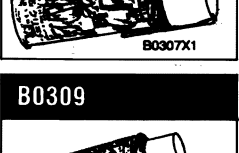
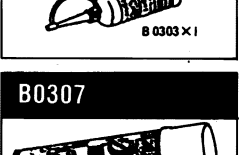
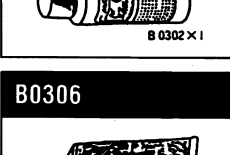
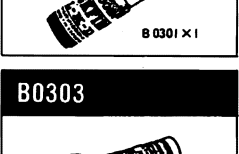
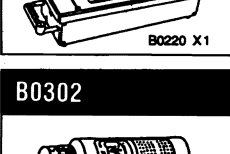
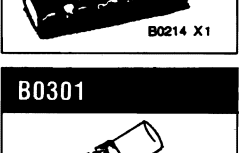
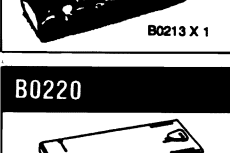
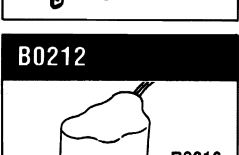
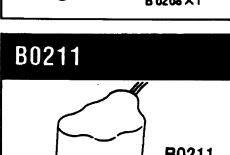
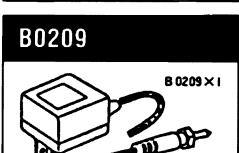
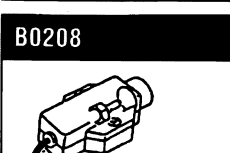
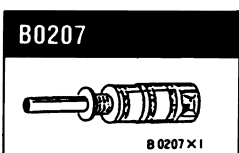
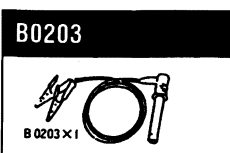
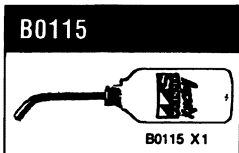
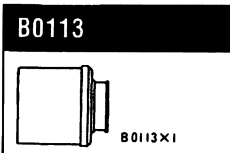
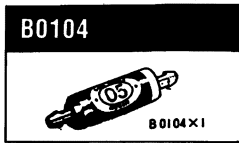

- B0103 FUEL FILTER L
- B0104 FUEL FILTER S
- B0113 AIR FILTER FOR (21 ON-ROAD)
- B0115 FUEL PUMP
- B0203 QUICK BOOSTER
- B0207 POCKET BOOSTER
- B0208 ADAPTER FOR POCKET BOOSTER
- B0209 BATTERY FOR POCKET BOOSTER
- B0211 POWER PACK 900 W/FUTABA 2+3
- B0212 POWER PACK 900 W/SANWA 2+3
- B0213 POWER PACK 900 W/FUTABA LINE
- B0214 POWER PACK 900 W/SANWA LINE
- B0220 PRO STARTER RII
- B0301 LOCK FIRM LIQUID
- B0302 AIR FILTER OIL
- B0303 ENGINE MAINTENANCE OIL
- B0306 RAD REZ
- B0307 PIT DE CLEANER
- B0308 SUPER GREASE
- B0309 AIR FILTER OIL (SPRAY)
- B0310 SUPER SILICON #100
- B0311 SUPER SILICON #150
- B0312 SUPER SILICON #200
- B0313 SUPER SILICON #250
- B0314 SUPER SILICON #300
- B0315 SUPER SILICON #350
- B0316 SUPER SILICON #400
- B0317 SILICON FOR DIFF. #10000
- B0318 SILICON FOR DIFF. #30000
- B0319 SILICON FOR DIFF. #50000
- B0320 SILICON FOR DIFF. #100000
- B0321 SILICON FOR DIFF. #3000
- B0322 SILICON FOR DIFF. #5000
- B0323 SILICON FOR DIFF. #7000
- B0324 SILICON FOR DIFF. #1000
- B0325 SUPER SILICON #500
- B0326 SUPER SILICON #600
- B0327 SUPER SILICON #700
- B0328 SUPER SILICON #800
- B0406 BOTH SIDE TAPE
- B0407 FLAT WASHER 3mm
- B0408 FLAT WASHER 4mm
- B0410 COLOR SILICON PIPE PINK
- B0411 COLOR SILICON PIPE GREEN
- B0412 COLOR SILICON PIPE YELLOW
- B0415 MUFFLER JOINT SILICON PIPE S
- B0416 COLOR STRAP SET 100mm
- B0417 COLOR STRAP SET 150mm
- B0422 BODY PIN
- B0506 SNAP RING PLIERS
- B0508 UTILITY WRENCH
- B0509 SETTING DRIVER FOR ENGINE
- B0510 CAMBER GAUGE
- B0512 CROSS WRENCH
- B0515 WORKS WRENCH 1.5mm
- B0516 WORKS WRENCH 2.0mm
- B0517 WORKS WRENCH 2.5mm
- B0611 M3X12 B/H TAPPING SCREW
- B0612 M3X15 B/H TAPPING SCREW
- B0630 M2.6X12 F/H TAPPING SCREW
- B0634 M2.6X16 F/H TAPPING SCREW
- B0635 M3X12 F/H TAPPING SCREW
- B0640 M4X10 F/H SCREW
- B0642 M3X12 F/H SCREW
- B0662 M3X8 CAP SCREW
- B0663 M3X12 CAP SCREW
- B0664 M3X16 CAP SCREW
- B0670 M3X3 SET SCREW
- B0671 M3X5 SET SCREW
- B0673 M3X8 SET SCREW
- B0674 M3X2.5 SET SCREW
- B0681 M4X5 SET SCREW
- B0711 SN4 NYLON NUT W/FLANGE (10pcs)
- B0712 SN2.6 NYLON NUT (10pcs)
- B0713 SN3 NYLON NUT (10pcs)
- B0714 SN4 NYLON NUT (10pcs)
- B0723 phi 3X8X0.5 WASHER (10pcs)



# 1/10 th SCALE 4WD GAS POWERED TOURING CAR MTX-2 PARTS LIST

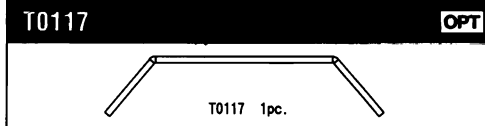
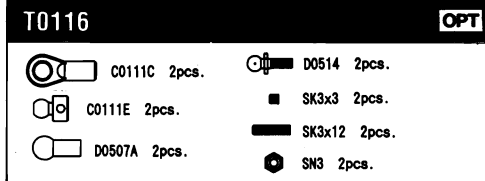
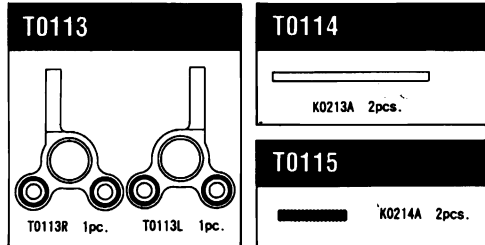
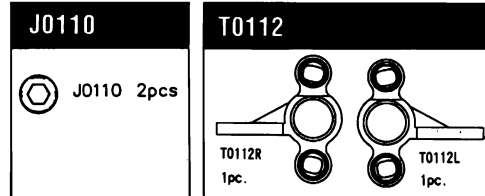
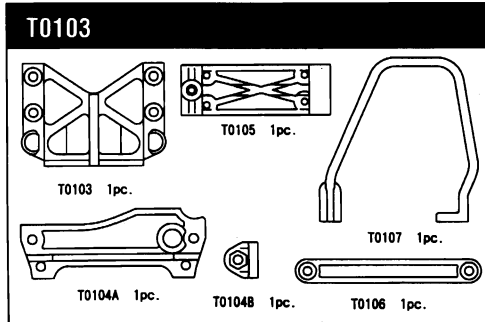
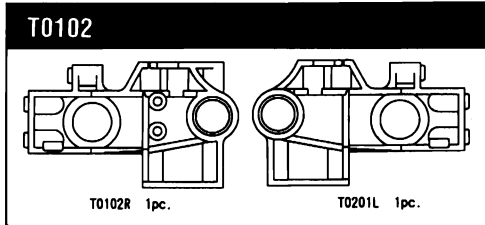
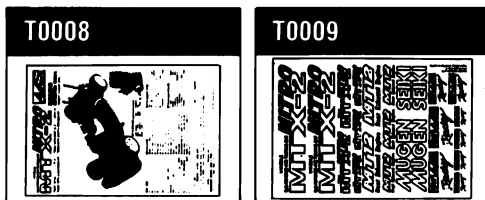

- T0008 INSTRUCTION MANUAL
- T0009 DECAL
- T0102 REAR BULK HEAD
- T0103 REAR END PARTS
- J0104 FRONT SUS. SHAFT
- D0105R KING PIN
- T0112 FRONT UPRIGHT
- J0110 ADJUSTING NUT
- T0113 REAR UPRIGHT
- T0114 REAR LOWER ARM PIN
- T0115 REAR UPPER ARM SHAFT
- T0116 ANTI-ROLL BAR LINK PARTS
- T0117 REAR ANTI-ROLL BAR  $\phi$  2.0mm

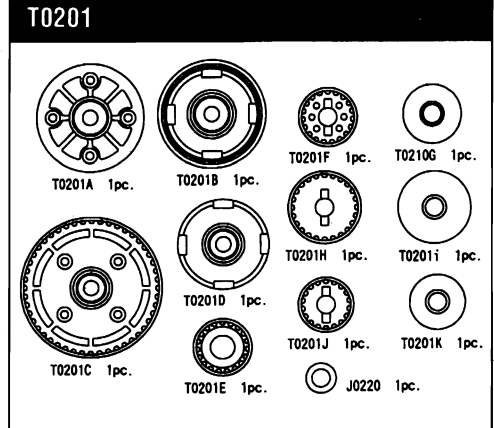
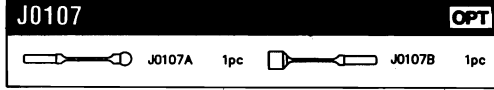
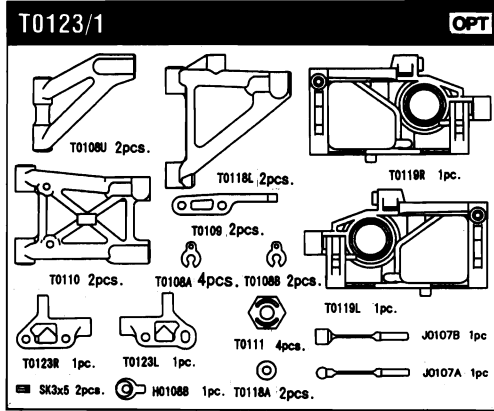
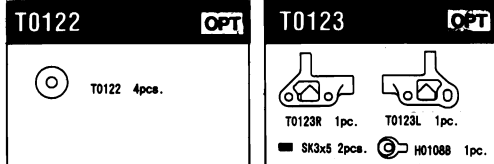
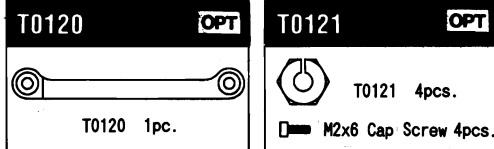
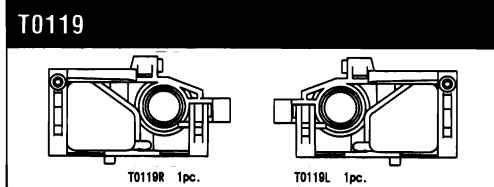
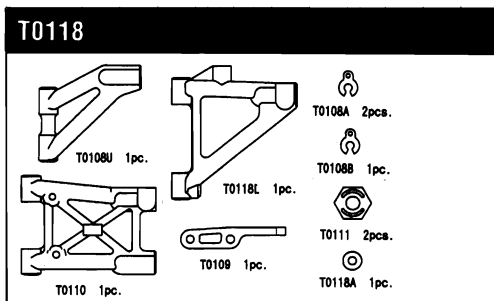

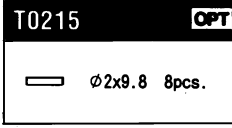
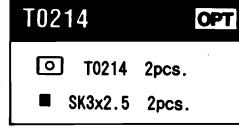
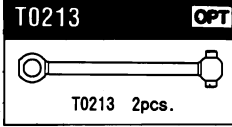
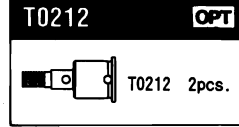
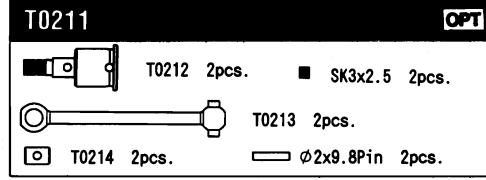
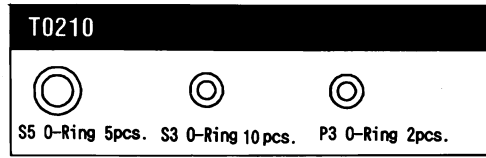
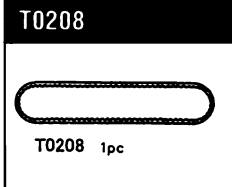
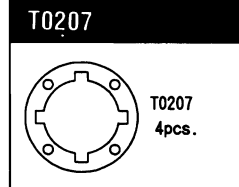
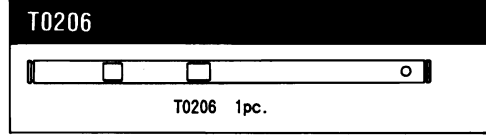
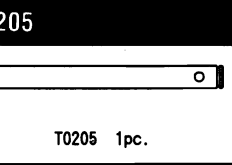
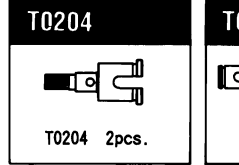
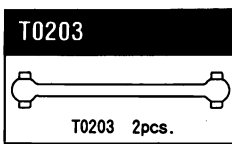
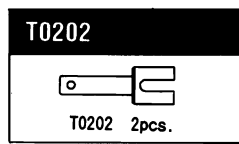

- T0118 SUS. ARM
- T0119 FRONT BULK HEAD
- T0120 AL. REAR BRACE
- T0121 AL. WHEEL HUB (4pcs.)
- T0122 WHEEL HUB SPACER
- T0123/1 FRONT ANTI-ROLL BAR SET
- T0123/1 FRONT ANTI-ROLL BAR HOLDER
- J0107 FRONT STABILIZER BAR
- T0201 PULLEY SET



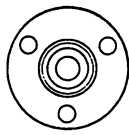

- T0202 DIFF. CUP JOINT
- T0203 F/R. DRIVE SHAFT
- T0204 F/R. AXLE SHAFT
- T0205 MIDDLE SHAFT
- T0206 2 SPEED SHAFT
- T0207 DIFF. GASKET
- T0208 BELT S
- T0209 BELT L
- T0210 O-RING SET
- T0211 F/R UNIVERSAL JOINT SET
- T0212 F/R AXLE SHAFT (FOR UNIVERSAL)
- T0213 F/R DRIVE SHAFT (FOR UNIVERSAL)
- T0214 JOINT SHAFT (FOR UNIVERSAL)
- T0215 JOINT PIN  $\phi$  2x9.8 (FOR UNIVERSAL)
- D0211 GEAR CHANGING DRIVE DISK

# MTX-2 パーツリスト

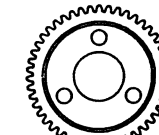

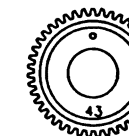
**D0213**  
 D0213 1pc  
 STW-17 1pc

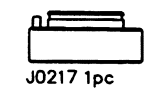
**D0214**  
 D0214 1pc  
 47T

**H0215**  
 H0215 1pc  
 43T

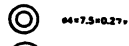
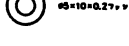
**J0217**  
 J0217 1pc  
 STW-20 1pc

**C0227**  
 44=7.5±0.27+/- 20pcs  
 45=10±0.27+/- 10pcs



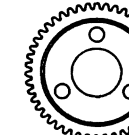

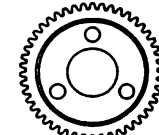
**C0228**  
 C0228A 2pc  
 C0228B 4pc  
 C0228C 2pc

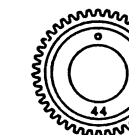
**D0225** **OPT**  
 D0225 1pc  
 48T

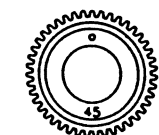
**D0226** **OPT**  
 D0226 1pc  
 49T

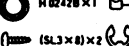
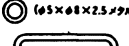

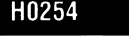
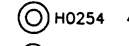
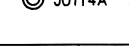
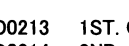
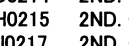
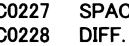
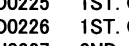
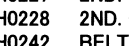
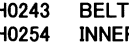
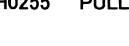
**H0227** **OPT**  
 H0227 1pc  
 44T

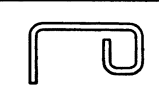

**H0228** **OPT**  
 H0228 1pc  
 45T

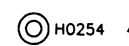
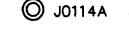

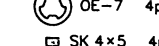

**H0242** **OPT**  
 H0242A x1  
 H0242B x1  
 H0242C x1  
 H0242D x1  
 H0242E x1  
 H0242F x1  
 H0242G x1  
 H0242H x1  
 H0242I x1  
 H0242J x1  
 H0242K x1  
 H0242L x1  
 H0242M x1  
 H0242N x1  
 H0242O x1  
 H0242P x1

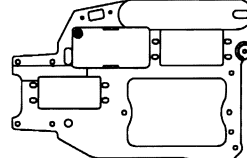
**H0243** **OPT**  
 H0243 1pc

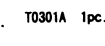
**H0254**  
 H0254 4pcs  
 J0114A 8pcs

**H0255**  
 H0255 1pc  
 OE-7 4pcs  
 SK 4x5 4pcs

**T0301**  
 T0301 1pc  
 T0301B 4pcs  
 T0301A 1pc

**J0306**  
 J0306A 1pc  
 D0306D 1pc  
 D0306E 1pc  
 D0306F 1pc

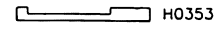
**H0353**  
 H0353 1pc

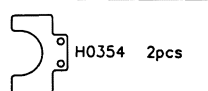
**H0354**  
 H0354 2pcs

**H0355**  
 H0355 2pcs

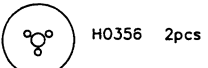
**H0356**  
 H0356 2pcs

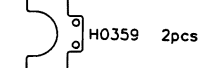
**H0359** **OPT**  
 H0359 2pcs

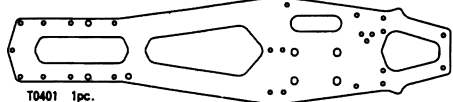
**T0401**  
 T0401 1pc

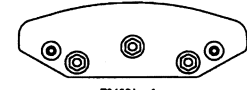
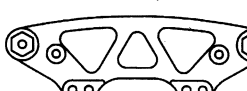
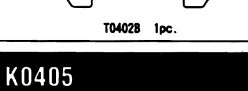
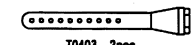
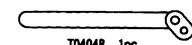
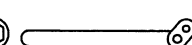

**T0402**  
 T0402A 1pc  
 T0402B 1pc  
 T0402C 1pc  
 T0403 2pcs  
 T0404 1pc  
 T0404L 1pc

**K0405**  
 K0405 1pc

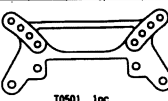
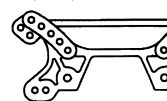

**T0405** **OPT**  
 T0405 1pc

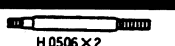
**T0501**  
 T0501 1pc  
 T0502 1pc

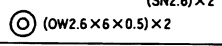
**C0502**  
 C0502 4pcs

**D0506**  
 D0506 x2  
 (SN2.6) x2  
 (OW2.6 x6 x0.5) x2

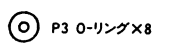

**D0508**  
 D0508 x8

**D0509**  
 D0509A x8  
 C0509C x4  
 P3 O-Ring x8







**H0510**  
 D0510F x2  
 D0510R x2





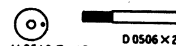
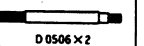
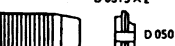

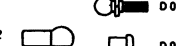
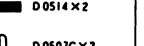
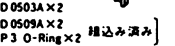
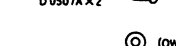

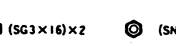
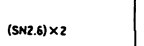
**J0511**  
 J0511 2pcs

**J0512**  
 J0512 2pcs

**H0513**  
 D0513 x2  
 S12 O-Ring x2  
 O-Ring

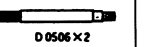
**D0514**  
 D0514 x4

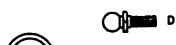
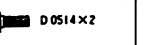
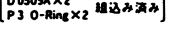
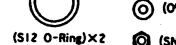
**H0521**  
 D0503B x2  
 D0513 x2  
 D0508 x2  
 H0510F x2  
 D0514 x2  
 D0503A x2  
 D0507B x2  
 D0507A x2  
 D0507C x2  
 D0509A x2  
 P3 O-Ring x2  
 (S12 O-Ring) x2  
 (SG3 x16) x2  
 (SN2.6) x2

**H0522**  
 D0503B x2  
 D0513 x2  
 D0508 x2  
 H0510R x2  
 D0506 x2  
 D0503A x2  
 D0507B x2  
 D0507A x2  
 D0514 x2  
 D0509A x2  
 P3 O-Ring x2  
 (S12 O-Ring) x2  
 (SN2.6) x2

**H0523 H0524**  
 H0523 2pcs  
 H0524 2pcs

**H0527 H0528 H0529**  
 H0527 2pcs  
 H0528 2pcs  
 H0529 2pcs

- D0213 1ST. GEAR HOUSING
- D0214 2ND. GEAR 47T
- H0215 2ND. GEAR 43T
- J0217 2ND. GEAR HOUSING
- C0227 SPACER
- C0228 DIFF. GEAR W/O-RING
- D0225 1ST. GEAR 48T
- D0226 1ST. GEAR 49T
- H0227 2ND. GEAR 44T
- H0228 2ND. GEAR 45T
- H0242 BELT TENSIONER
- H0243 BELT TENSIONER WIRE
- H0254 INNER DRIVE JOINT WASHER
- H0255 PULLEY BRAKE ADAPTER

- T0301 RADIO PLATE
- J0306 SERVO SAVER
- H0353 BRAKE CAM
- H0354 BRAKE PLATE
- H0355 BRAKE PAD
- H0356 BRAKE DISK
- H0359 TEFLON BRAKE PAD
- T0401 CHASSIS
- T0402 FRONT BUMPER
- K0405 URETHANE BUMPER
- T0405 FRONT WIDE BUMPER
- T0501 DAMPER STAY

- C0502 PIVOT BALL
- J0511 FRONT SPRING
- J0512 REAR SPRING
- D0506 REAR DAMPER SHAFT
- D0508 DIAPHRAGM
- D0509 O-RING SET
- H0510 DAMPER PISTON
- H0513 SPRING ADJUSTER
- D0514 DAMPER PIVOT BALL
- H0521 FRONT DAMPER
- H0522 REAR DAMPER
- H0523 FRONT DAMPER SPRING PURPLE φ 1.6mm
- H0524 FRONT DAMPER SPRING LIGHT BLUE φ 1.7mm
- H0525 FRONT DAMPER SPRING GRAY φ 1.8mm
- H0526 FRONT DAMPER SPRING WHITE φ 1.9mm
- H0527 REAR DAMPER SPRING PURPLE φ 1.6mm
- H0528 REAR DAMPER SPRING LIGHT BLUE φ 1.7mm
- H0529 REAR DAMPER SPRING GRAY φ 1.8mm
- H0530 REAR DAMPER SPRING WHITE φ 1.9mm
- H0531 REAR DAMPER SPRING PINK φ 2.0mm